

**Honeywell**

# **Voice Maintenance & Inspection Solution 1.9**

**Implementation Guide**

# Disclaimer

Honeywell International Inc. ("HII") reserves the right to make changes in specifications and other information contained in this document without prior notice, and the reader should in all cases consult HII to determine whether any such changes have been made. The information in this publication does not represent a commitment on the part of HII.

HII shall not be liable for technical or editorial errors or omissions contained herein; nor for incidental or consequential damages resulting from the furnishing, performance, or use of this material.

This document contains proprietary information that is protected by copyright. All rights are reserved. No part of this document may be photocopied, reproduced, or translated into another language without the prior written consent of HII.

© 2022 Honeywell International Inc. All rights reserved.

Other product names or marks mentioned in this document may be trademarks or registered trademarks of other companies and are the property of their respective owners.

Web Address: [www.sps.honeywell.com](http://www.sps.honeywell.com)

Other product names or marks mentioned in this document may be trademarks or registered trademarks of other companies and are the property of their respective owners.

# Patents

For patent information, please refer to [www.hsmpats.com](http://www.hsmpats.com)

# TABLE OF CONTENTS

<b>Chapter 1 - Introduction</b> .....	<b>1</b>
Customer Support .....	1
<b>Chapter 2 - Hosting Options</b> .....	<b>5</b>
Local Hosting .....	5
Hardware Configuration for VoiceCheck .....	5
Cloud Hosting .....	8
Set up the Cloud Environment .....	8
Cloud Maintenance and Security .....	9
VoiceCheck Installation .....	9
Before You Install VoiceCheck .....	9
Running the Installation Program .....	11
Solution Architecture Options .....	16
Decentralized vs. Centralized Models .....	16
Decentralized Architecture .....	16
Centralized Architecture .....	16
Single Server vs. Multiple Server Models .....	17
Single Application Server Solution .....	17
Multi-Server/Multi-Site Solution .....	17
Database Servers .....	18
Clustered Environments .....	18
Installing into a Clustered Environment .....	21
Cluster Installation Steps for Windows Server .....	21
Installing to a Clustered Database .....	22

Network Configuration .....	22
Network Protocols and Ports .....	22
VoiceCheck Upgrades .....	24
Standard Upgrade .....	24
Upgrading from a Standard Installation to a Clustered Environment .....	25
Post-Installation Steps .....	25
Database Maintenance Plan .....	25
Initial Database Connection Pool Settings .....	26
Apache Tomcat Performance Tuning .....	26
Java Virtual Machine Settings .....	27
First System Log On .....	27
Creating Additional Sites for Multi-Site Implementations .....	28
Creating Multiple Sites in VoiceCheck .....	30
Setting Up Application Security .....	30
Operators versus Users .....	31
Creating Operators and Users .....	32
Setting Up User Authentication .....	33
Setting Up the Export Web Service .....	33
Setting Up a Transcription Server .....	34
Setting Up a Transcription Service Endpoint .....	36
Setting Up Job Schedules .....	37
Setting Up Email Notifications .....	37
Security Considerations .....	38
Options for Securing Your Implementation .....	38
Failover and Recovery .....	41
Uninstalling VoiceCheck .....	43
Solution Implementation Checklist .....	44
HTTPS Certificate Installation .....	46
Creating a Certificate Signing Request .....	46
Getting a Certificate from a Certificate Authority .....	47

Installing the Certificate .....	47
Configuring Tomcat with Keystore Information .....	47
VoiceCheck 1.8x Functionality .....	48
<b>Chapter 3 - User Options .....</b>	<b>51</b>
<b>Chapter 4 - Android Supported Environments .....</b>	<b>53</b>
Component Functions .....	55
Mobile App Settings .....	56
Mobile Device Management .....	57
Create Configuration File .....	58
Upload Configuration File .....	58
Headset and Android Device Pairing .....	59
SRX3 Headset Pairing .....	59
Getting Started .....	60
Initial Setup .....	61
<b>Chapter 5 - Talkman A700x .....</b>	<b>65</b>
Solution Overview .....	66
Technician Training .....	69
Headset and Talkman Pairing .....	69
SRX3 Headset Pairing .....	69
Training on Honeywell Voice and Devices .....	73
Talkman Reference Guide .....	75
<b>Chapter 6 - VoiceCatalyst M&amp;I for PC .....</b>	<b>79</b>
Training on Honeywell Voice and Devices .....	83
<b>Chapter 7 - VoiceConsole and Device Setup .....</b>	<b>85</b>
Importing VoiceCatalyst MI .....	88
Creating a Device Profile .....	89
Securing Device Communications .....	89
Persistent Pairing of Headset and Device .....	91

Importing a Task and Creating a Task Package .....	91
Task Package Settings in VoiceConsole .....	92
Configuring Talkman Devices .....	96
Loading a Task Package .....	98
<b>Chapter 8 - System Maintenance and Protection .....</b>	<b>99</b>
Changes to Master Data and VoiceForms .....	99
Changing Purge Intervals .....	101
Database Maintenance .....	102
System Configuration .....	102
Editing System Configuration Properties .....	103
Field Definitions .....	103
Troubleshooting .....	105
Notifications and Logs .....	109
VoiceCheck log .....	109
VoiceCheck Error Log .....	110
Honeywell Log and Error Log .....	110
<b>Chapter 9 - Data Transmission .....</b>	<b>113</b>
VoiceForm Web Services .....	116
Create VoiceForm Details .....	116
READ VOICEFORM DETAILS .....	117
UPDATE VOICEFORM DETAILS .....	117
DELETE VOICEFORM DETAILS .....	117
Manage Images .....	117
INPUT ELEMENTS .....	118
VoiceForm Version Web Services .....	118
Create VoiceForm Version .....	118
READ VOICEFORM Version .....	119
INPUT ELEMENTS .....	119
Import/Export Operators .....	119

Import Operators .....	119
Export Operators .....	120
Import/Export Steps .....	121
Import Steps .....	121
Export Steps .....	121
VoicePlan Web Services .....	122
INPUT ELEMENTS .....	123
Assignment Web Services .....	123
Input Elements .....	125
Rules for Step Dependencies .....	128
Step Occurrence in Inspection Plans .....	128
Close Assignment Web Service .....	129
Close Assignment Details .....	130
Post Assignment Results Web Service .....	131
REST Web Service .....	131
SOAP Web Service .....	132
Input Details .....	133
Assignment Export .....	137
Get Available Exports .....	137
Get An Export .....	137
Mark Export as Received .....	137
Get Photo Web Service .....	138
REST Web Service .....	138

**Appendix A - Maintenance & Inspection Version History ..... 139**





# INTRODUCTION

The Honeywell Voice Maintenance & Inspection Solution is designed to integrate with and support various IT infrastructures, databases, and operating systems.

Depending on your system configuration, the hardware and software requirements may vary. Review the pages in this section to ensure your configuration is sufficient for a supported implementation of the Honeywell Voice Maintenance & Inspection Solution.

- [Plan your implementation.](#)
- [Install and configure VoiceConsole.](#)
- [Install VoiceCheck.](#)
- [Obtain and install an HTTPS certificate.](#)
- [Prepare Talkman devices for inspection work.](#)
- [Understand web services used for data import and export.](#)
- [Understand system configuration settings.](#)
- [Provision your cloud setup.](#)

To get started, [first configure your hosting solution](#) then [configure user options](#).

## Customer Support

Find most Honeywell Voice technical documentation [help.honeywellaidc.com](http://help.honeywellaidc.com)

## Honeywell Reseller Services

If you purchased equipment or services through a Vocollect reseller, please contact your reseller first for support or to purchase a support plan.

## Honeywell Technical Support

Submit incidents or questions to <http://honeywell.custhelp.com> or contact Honeywell Technical Support Center:

United States:

E-mail: [VoiceTechnicalSupport@honeywell.com](mailto:VoiceTechnicalSupport@honeywell.com)

Phone: 866 862 7877

Americas (outside U.S.), Australia, New Zealand:

E-mail: [VoiceTechnicalSupport@honeywell.com](mailto:VoiceTechnicalSupport@honeywell.com)

Phone: 412 829 8145, Option 3, Option 1

Europe, Middle East, and Africa:  
E-mail: [VoiceTechnicalSupport@honeywell.com](mailto:VoiceTechnicalSupport@honeywell.com)  
Phone: +44 (0) 1344 65 6123

Japan and Korea:  
E-mail: [vocollectJapan@honeywell.com](mailto:vocollectJapan@honeywell.com)  
Phone: +813 3769 5601

## Honeywell Customer Service

Contact Honeywell Customer Service for order placement, order status, returns, Return Material Authorization (RMA) status, or other customer service issues:

United States:  
E-mail: [vocollectRequests@honeywell.com](mailto:vocollectRequests@honeywell.com)  
Phone: 866 862 6553, Option 3, Option 2

Americas (outside U.S.), Australia, New Zealand:  
E-mail: [vocollectRequests@honeywell.com](mailto:vocollectRequests@honeywell.com)  
Phone: 412 829 8145, Option 3, Option 2

Europe, Middle East, and Africa:  
E-mail: [vocollectCSEMEA@honeywell.com](mailto:vocollectCSEMEA@honeywell.com)  
Phone: +44 (0) 1344 65 6123

Japan and Korea:  
Email: [vocollectJapan@honeywell.com](mailto:vocollectJapan@honeywell.com)  
Phone: +813 6730 7234

## Honeywell RMA

To return equipment for repair contact Honeywell RMA to request an RMA number.  
Email: [ACSHSMVocollectRMA@honeywell.com](mailto:ACSHSMVocollectRMA@honeywell.com)

## Sales and General Inquiries

For sales or any other inquiry, email [vocollectinfo@honeywell.com](mailto:vocollectinfo@honeywell.com) or call 412 829 8145.

**Honeywell**  
703 Rodi Road  
Pittsburgh, PA 15235 US  
Phone: +1 412 829 8145  
Fax: +1 412 829 0972  
Web: <http://vocollectvoice.com>

**Honeywell**

**Vocollect Solutions Japan**

New Pier Takeshiba South Tower 20F

1-16-1 Kaigan Minato-ku,

Tokyo 105-0022 Japan

Phone: +813 6730 7234

[vocollectJapan@honeywell.com](mailto:vocollectJapan@honeywell.com)

**Honeywell**

**Vocollect Solutions Europe**

Honeywell House

Skimped Hill Lane

Bracknell, Berkshire

HP10 0HH UK

Phone: +44 (0) 1628 55 2900

[vocollectEMEA@honeywell.com](mailto:vocollectEMEA@honeywell.com)

**Honeywell**

**Vocollect Solutions Asia-Pacific**

21/F Honeywell Tower

Olympia Plaza

255 King's Road

North Point, Hong Kong

Phone (Hong Kong): +852 2331 9133

Phone (China): +86 186 1698 7028

Phone (Australia): +61 409 527 201

[vocollectAsiaPacific@honeywell.com](mailto:vocollectAsiaPacific@honeywell.com)

**Honeywell**

**Vocollect Solutions Singapore**

151 Lorong Chuan

#05-02A/03 (Lobby C)

New Tech Park

Singapore 556741

Phone (Singapore): +65 6248 4928

[vocollectSingapore@honeywell.com](mailto:vocollectSingapore@honeywell.com)

**Honeywell**

**Vocollect Solutions Latin America**

Phone (North): +52 55 5241 4800 ext. 4915

Phone (South): +1 412 349 2477

[vocollectLatin\\_America@honeywell.com](mailto:vocollectLatin_America@honeywell.com)



# HOSTING OPTIONS

The VoiceCheck server can be hosted on a local machine or in the cloud.

If you have already set up your hosting solution, you are ready to perform your See "VoiceCheck Installation" on page 9 for more information.

## Local Hosting

When you plan your Honeywell Voice Maintenance & Inspection Solution implementation, you must scale your hardware resources to meet the minimum requirements for the expected load. For your VoiceConsole server, determine the number of devices to be supported at a time. For your VoiceCheck server, consider the number and size of assignments and the number of technicians performing inspections concurrently.

Honeywell has tested the following hardware configuration under various loads.

- One physical VoiceConsole application server (for Talkman only)
- One physical VoiceCheck application server
- One physical database server with two MS SQL Server databases

## Hardware Configuration for VoiceCheck

When supporting 300 to 600 devices, Honeywell recommends that you install a single VoiceCheck application server and a single database server.

Application Server	
Processor	3 x Dual Core, 3.0 GHz
Memory	3 x 4 GB DDR Note: Physical memory greater than 4 GB requires a 64-bit operating system.
Hard Drive	120 GB
Drive Speed	15000 rpm
DVD Drive	Yes
Server Network Switch	1 Gb
WAN Throughput	Sufficient resources to support 387404.88 bps to 774809.84 bps data transfer

## Database Server

Processor	1 processor or simulated processor for every 150 to 200 concurrent technicians , 2.5 to 3.0 GHz
Memory	1 GB for every 200 concurrent technicians
Hard Drive	1 GB for every 50,000 steps. For example, for 10,000 assignments with about 200 steps per assignment, the database would require 40 GB of space without any data purge. $(10,000 * 200) / 50,000 = 40$
Server Network Switch	1 Gb
WAN Throughput	Sufficient resources to support 387404.88 bps to 774809.84 bps data transfer

### NOTE

The number of technicians and client workstations put different demands on the database. For best performance, Honeywell recommends implementing hardware configurations on the high end of the requirements.

## Supported Environments

### Supported Environments

VoiceCheck Server Operating System	<ul style="list-style-type: none"><li>• Microsoft Windows Server 2022</li><li>• Microsoft Windows Server 2019</li></ul>
VoiceCheck Server Database	<ul style="list-style-type: none"><li>• Microsoft SQL Server 2019</li><li>• Microsoft SQL Server 2017</li><li>• Oracle 19c</li></ul>
VoiceCheck Application Server	<ul style="list-style-type: none"><li>• Apache Tomcat version 9.0.63</li></ul>
VoiceCheck Web Browser	<ul style="list-style-type: none"><li>• Google Chrome 31.x and newer</li><li>• Mozilla Firefox v. 20.0 and newer</li></ul>
VoiceCheck Languages	<ul style="list-style-type: none"><li>• U.S. English (en_US)</li><li>• German (de_DE)</li><li>• Latin American Spanish (es_MX)</li><li>• Japanese (ja_JP)</li><li>• French Canadian (fr_CA)</li><li>• European French (fr_FR)</li><li>• Netherlands Dutch (nL_NL)</li></ul>

### IMPORTANT

See the VoiceConsole Implementation Guide for detailed requirements for that product.

## Required Solution Components

In addition to the server hardware, the operating system and databases, VoiceConsole, and VoiceCheck, you will need components that deliver voice instructions to your technicians.

### Devices Running Maintenance & Inspection App

VoiceCheck is supported on the Talkman A700x series and Honeywell Android devices.

- The Talkman A730x has an integrated scanner that supports short-range scanning of 1D and 2D barcodes. Other Talkman A700x solution devices are available if the scanning feature is not needed.
- Optional belts and holsters are available if you intend your technicians to wear the Talkman devices.
- Honeywell recommends purchasing one device for every non-overlapping technician per shift.
- Honeywell CT40 with Android 11
- Honeywell CT40XP with Android 11
- Honeywell CT45 with Android 11
- Honeywell CT60 with Android 11
- Honeywell CT60XP with Android 11

### Honeywell SRX3 Wireless Headsets

- These speech-recognition headsets feature industrial grade use of Bluetooth wireless technology, optimal noise cancellation, an adjustable microphone boom, and a lightweight headband.
- The headset electronics module may be shared among technicians, while the headband remains assigned to a single user for hygiene purposes.
- Accessories are available to fit different work environments.
- At a minimum, Honeywell recommends purchasing one headband for every technician and one electronics module for every non-overlapping technician per shift.

### Honeywell device/battery chargers

- The Talkman A700x solution offers a 6-Bay Device Charger and a 12-Bay Battery Charger, both capable of being wall mounted.
- The SRX3 Headset Battery Charger can charge up to 20 batteries at one time, and it can be wall mounted to keep it secure.

### Battery Performance

From a full charge, a standard Talkman A700x battery has 14 hours of projected life. An A700x high capacity battery has 24 hours of projected life.

Standard Talkman batteries will meet the requirements of a full shift operation in room-temperature environments and typical A700x device configurations for about 1.5 years. High capacity batteries will meet the requirements of a full shift operation in room-temperature environments and typical A700x device configurations for about 3 years.

The SRX3 headset batteries with a full charge last up to 20 hours at room temperature.

## Cloud Hosting

Honeywell officially supports running VoiceCheck in a Cloud environment. The Honeywell testing environment is the Microsoft Azure platform for Cloud hosting.

### IMPORTANT

Other environments can be used so long as it meets the expected requirements. Honeywell cannot account for all variables and unknowns with other Cloud environments, but this a list of best practices. Should an issue be encountered due to these unknowns, Honeywell will provide best effort support to determine if the problem relates to our solution or the environment and help to pin point the cause.

For more information on Azure, refer to the [Azure documentation](#).

## Set up the Cloud Environment

### Machine Requirements

When planning a Cloud installation, Honeywell recommends following the [server requirements](#) for local hosting with an additional margin to allow for Cloud latency. Consult with [Technical Support](#) or [Professional Services](#) for further questions regarding Cloud system specifications.

### Sample Configuration

The following example is provided for an operation which might see 150-600 operator shift start size.

- Quad Core CPU
- Minimum 16GB RAM
- Minimum 60 GB storage space
- Microsoft Windows Server 2019 OS
- Database
  - Microsoft SQL Server 2019 database has been tested. The database is installed on a separate server and is not included in the machine requirements above.

### Ports

The following ports must be opened by the Network/Cloud Management team:

- 9090 bi-directional
- 9091 bi-directional
- 9443 bi-directional
- 21050 outbound
- 9070 bi-directional
- 9071 bi-directional



More information on these ports can be found [here](#).

## General Information

- Honeywell does not recommend leaving VoiceCheck as a public-facing Internet accessible application.
- Talkman devices cannot be configured to directly utilize a VPN connection.
- File transfers, may take longer in a cloud environment than in a local installation.

## Contact Support Regarding Known Issues

Contact Technical Support for information regarding the following known issues.

- Azure high latency storage block issues with log files
- An Azure SQL managed database instance that is not supported

# Cloud Maintenance and Security

This page describes the post requisition steps for hosting VoiceCheck on the cloud.

## Security Considerations

The password policy for VoiceCheck on the cloud is the same as the policy for local installation.

### IMPORTANT

LDAP authentication cannot be used unless you have a public Directory Server to allow authentication from Azure.

# VoiceCheck Installation

This section covers actions you must take, information you need before you install the system, and steps on how to install the system.

## Before You Install VoiceCheck

Take these required actions and gather the required resources before running the VoiceCheck installer.

### Required Security Privileges

To successfully run the installer, the user must have Local Administrator privileges for the machine.

## Virus Protection Software and Other Programs

Disable any virus protection software and exit all programs before starting the VoiceCheck installation.

## Database Installation

If one is not already available, install a supported database platform.

Create a blank VoiceCheck database and a user with create, read, and write permissions to the database. When you run the installer in the next step, the database schema will be created automatically.

When creating the database, keep the following in mind:

- Spaces and characters – Do not use spaces in the database name. Also avoid using special characters.

### CAUTION

Spaces and special characters can result in creating an invalid JDBC URL.

- TCP/IP protocol – Enable TCP/IP. The process to do this differs by database. Note that you most likely will have to restart the database service after making this change.
- Collation and accent methods – Use the proper database collation (sorting method) for the language in use, and append “\_CI” and “\_AI” as needed to the database collation name. To add both parameters for SQL Server, append “\_CI\_AI.” For Oracle, “\_AI” also includes a case-insensitive sort.

If the SQL Server or Oracle database collation is not set to be case insensitive (CI), VoiceCheck may not work properly. Similarly, an accent-insensitive (AI) sort may be required for a specific language.

- Database size – Use the defaults for the initial database size.
- Maintenance – Plan and run regular backups, maintain the size of the transaction log, and rebuild indexes periodically.

### Microsoft SQL Server

- If you create a new login for SQL Server, that login must have dbOwner privileges. dbOwner privileges are required to run the application after installation.

### Oracle

- In Oracle, ensure you are using the **AL32UTF8** character set for non-English versions of VoiceCheck.
- Permissions – The database user that VoiceCheck will use must be granted the connect and resource roles. The user also needs permissions to create tables, sequences, and views.

## Browser Configuration

Prior to installation, your browser must be configured properly. Regardless of which browser you are using, you must configure it to enable the application to work correctly and provide security.

- The browser must be set to reload the page at each visit.
- JavaScript must be enabled.
- The browser must be configured to accept cookies.
- The browser must be set to open new pages in a new tab or window.

These browser settings are typically accessed by selecting **Tools > (Internet) Options**.

## Information and Resources Required for Installation

- The VoiceCheck contents of your Honeywell Voice Maintenance & Inspection Solution DVD.
- The directory where the installation program should install the VoiceCheck folders.
- On Windows systems, the default is *C:\Program Files\Vocollect\VoiceCheck*
- The hostname of the machine on which VoiceCheck will be installed.
- The port that the Web Application should use. The default is 9070.
- The database information for the type of database server used.
- A valid HTTPS certificate for the VoiceCheck server if you plan to use encryption in data communications.
- When you install VoiceCheck, the following components are also installed on the server.
  - Apache Tomcat 8.5.24
  - Java JRE 1.8
  - VoiceCheck Web Application
  - VoiceCheck Online Help
- When you install VoiceCheck for the first time, two users are created with default passwords:
  - User = admin; password = admin
  - User = vocollect; password = voiceworks

## Running the Installation Program

This section covers how to install the Honeywell applications using the installation user interface.

### CAUTION

To avoid potential issues, Honeywell recommends installing VoiceCheck directly from a local drive or from the distribution media. If the application is installed from a shared network drive, you may experience interruptions and failures.

- Close all other applications before installing
- When installing on Windows, run the installer as an administrator.
- If installing from a product DVD, navigate to and run **install.exe**.

## Introduction

The installation begins with an introduction screen.

Click **Next**.

## License Agreement

Accept the terms of the license agreement and click **Next**.

## Select Installation Path

Click **Next** to install to the default path or, if necessary, browse to the desired installation path and click **Next**.

## Software to Install

Click **Next** to start copying the required software files.

## Copying Software

During this step, VoiceCheck software files copy to the installation path. When the copy process is finished, click **Next**.

## Cluster Configuration

Select No to continue a standard installation and click Next.

Select Yes if you want this installation to be part of a clustered environment. Specify a folder location for shared storage, then click Next. See "Installing into a Clustered Environment" on page 21 for more information.

### IMPORTANT

You must enter a full UNC path, including the application server hostname, to the shared storage location during a cluster installation. Do not reference a mapped drive or relative path.

## Configuration and Installation

This page contains three tabs for configuring your implementation of VoiceCheck.

1. Click the **Tomcat Server Configuration** tab.
2. Enter the appropriate information for your Tomcat server.

Tomcat Field	Description and Required Action
--------------	---------------------------------

Tomcat Login	Choose an account and enter the account username and password, if necessary.
--------------	--

Tomcat Field	Description and Required Action
--------------	---------------------------------

In Windows, if you select **Use Existing Account**, ensure the account entered has the necessary permissions:

- Read permission to the directory from which the installation program is being run
- **Log on as a service** rights and permissions (refer to <http://support.microsoft.com/kb/327545> for setup information).
- Write permissions to all paths provided during installation for the install folder, log files directory, application files location
- Write permissions to the shared drive for a clustered install (if applicable)

**NOTE**  
If you want to use NT authentication for SQL Server databases for a Windows installation, you must use an existing account.

Tomcat Path	Confirm the default path to the location where log files will be stored or, if necessary, browse to the desired path. Log files track user activities in the VoiceCheck application.
Tomcat Port	Confirm the default ports the application server will use, or, if necessary, enter different ports.

3. Click the **Database Configuration** tab.
4. Enter the appropriate information for your database.

### Microsoft SQL Server

Field	Description
Data Hostname	DNS name or IP address of the machine hosting the database.
Database Port	The port that the database uses. Valid entry must be an integer between 1 and 65535. The default port for SQL Server is 1433.
Database Name	The name of the database.
JDBC URL (Advanced Settings only)	The JDBC URL for the database. Valid entry format: jdbc:sqlserver://<host>:<port>;

## Microsoft SQL Server

	DatabaseName=<database name>
Authentication Type (for Windows installs only where an existing user was specified for the Tomcat Server configuration)	The authentication type used to connect to the database. If installing on Windows and an existing user was specified for the Tomcat Service configuration, you can select to use NT Authentication. Otherwise, select SQL Server Authentication.
Database Username	The username that the application should use to log into the database. This is disabled if using NT Authentication.
Database Password	The password of the user that the application should use to log into the database. This is disabled if using NT Authentication.
Database schema	The database schema you are using.

## Oracle Database

Field	Description
Data Hostname	DNS name or IP address of the machine hosting the database.
Database Port	The port that the database uses. Valid entry must be an integer between 1 and 65535. The default port for Oracle is 1521.
SID	The SID of the Oracle database.
JDBC URL (Advanced Settings only)	The JDBC URL for the database. Valid entry format: jdbc:oracle:thin:@<host>:<port>:<database name>
Database Username	The username that the application should use to log into the database.
Database Password	The password of the user that the application should use to log into the database.

5. Click the **VoiceCheck Configuration** tab.
6. In the **Storage Directory** field, keep the default VoiceCheck installation path or browse to a different location. The storage directory must have sufficient space to store multiple VoiceNotes and photo files.

7. Check the **Enable HTTPS Support** checkbox if you want to enable secure HTTPS on all pages of VoiceCheck.
  - a. Enter or browse to your HTTPS certificate **Keystore Location**.
  - b. Enter your **Keystore Password** and **Keystore Alias**.
8. Click **Install Now**.
9. When the initial VoiceCheck installation completes, click **OK**.

## Setup Shortcuts

If desired, select the Start menu program group in which to place the VoiceCheck shortcut, or edit the path of the shortcut. Then click **Next**.

If you do not want a VoiceCheck shortcut on the Start menu, clear the **Create shortcut in the Start menu** checkbox. A shortcut to VoiceCheck is placed on the desktop after the installation process completes.

## Installation Complete

When the installation is complete, a success message displays with information about the uninstaller program.

If desired, click the **Generate script** button to generate an .xml file containing your installation selections. You can use this script to perform additional silent or automatic installations.

Click **Done** to exit the installation program. The VoiceCheck application should open automatically in your supported browser.

## HTTPS Installation Not Running

If you enabled HTTPS support during the installation and VoiceCheck does not start up properly, check your HTTPS certificate keystore information and correct the values in the Tomcat server as needed. See "Configuring Tomcat with Keystore Information" on page 47 for more information. for instructions on manually editing the keystore fields.

## Configure Photos URL

The installer does not ask for a host name during installation, so the name "localhost" is used for the hostname. If the URL used to connect to VoiceCheck is `http://localhost:9070/VoiceCheck/` the exported URL for photos uses localhost rather than the server name or server IP address.

To reconfigure the URL to use the server name or IP address, open the server.properties file located at `C:\Program Files\Vocollect\VoiceCheck\tomcat\webapps\VoiceCheck\WEB-INF\classes\server.properties`, which is the default installation location. The file should look like this:

```
server.port=80
server.name=localhost
server.scheme=http
server.contextRoot=VoiceCheck
server.https.port=443
server.https.enabled=true
```

Change `server.name=localhost` to `server.name=<your IP address or DNS host name>`.

## Storage of Database Passwords

The installation program stores the `database.properties` file in the target installation folder. This file includes the database password and username that the application uses to log into the database (unless you are using SQL Server with NT Authentication). While the passwords in this file are encrypted, this file is a plain text file that can be read by any text editor. Therefore, if you want to secure this file, follow the appropriate steps to secure it with file permissions.

### Related Topics

See "VoiceCheck Installation" on page 9 for more information.

## Solution Architecture Options

Honeywell Voice Maintenance & Inspection Solution can be installed with different architecture models, depending on requirements and available resources.

## Decentralized vs. Centralized Models

### Decentralized Architecture

A decentralized architecture model installs solution components at each site where voice is supported. In this model, the VoiceConsole and VoiceCheck applications and their related databases are installed at every site.

This type of installation enables the application to be installed and upgraded locally and limits the reliance on remote access.

### Centralized Architecture

Honeywell Voice Maintenance & Inspection Solution can be implemented with a centralized architecture model, where one instance of VoiceConsole and one instance of VoiceCheck provide inspection management features for technicians working at multiple sites. In this scenario, the databases and applications are installed at a single site, and that installation is used to monitor and record inspection functions being performed at one or more remote sites.

### Benefits

- **Centralized Management:** VoiceCheck does not need to be implemented separately at each site or distribution center.
- **Site-Segregated View:** A user with the proper privileges can easily switch between one site's data and another site's data.
- **Secure Access:** Only users with the proper privileges can view and manage multiple sites.



- **Importing Software Components Across Multiple Sites:** A user can import data for multiple sites on one server.

## Considerations

- **Network Requirements:** Network bandwidth must be sufficient to handle activity at all managed sites, especially at shift starts. Remote access must be secure and provide sufficient performance for technicians accessing the VoiceCheck user interface.
- **No Multiple Site View:** You can manage multiple sites from one browser session, but not simultaneously from separate browser windows or tabs. You must switch between the sites using the Site dropdown box.

# Single Server vs. Multiple Server Models

## Single Application Server Solution

VoiceCheck and VoiceConsole can be installed on the same server, in any order, but cannot share the same database. However, the database information for the first application installed can often make it easier to install the second application.

The two applications do require separate installations of Apache Tomcat and must be configured to use separate TCP/IP communication ports in order to avoid port conflicts. Honeywell recommends that the first installed application be running when the second is installed so that ports in use can be detected.

## Multi-Server/Multi-Site Solution

If you plan to install VoiceCheck and VoiceConsole on separate servers **and** configure multiple sites in each application, there are important issues to consider in planning. A site is the location where a technician, who is wearing a Talkman device and following a voice-directed workflow, is working.

See also See "Creating Additional Sites for Multi-Site Implementations" on page 28 for more information. for instructions on creating additional sites in both applications.

## Time Zone Considerations in Multi-Site Implementations

Time zones affect the time stamps that are recorded for VoiceCheck and VoiceConsole activity.

- Actions performed by technicians: The time zone is defined by the VoiceConsole site with which each device is associated. Therefore, time stamps in device messages are set according to the time zone on the VoiceConsole server.
- Actions performed by VoiceConsole users: The time stamps are set by the VoiceConsole server.
- Actions performed by VoiceCheck users: The time stamps are set by the VoiceCheck server.

Both VoiceCheck and VoiceConsole have rules about when certain actions can be performed. If time stamps differ, due to either of the following scenarios, it can cause unexpected errors.

- **Multi-Server Implementations:** In implementations where VoiceCheck and VoiceConsole are installed on different servers, the time on these must be servers synced. This is not an issue if VoiceCheck and VoiceConsole are installed on the same server.
- **Multi-Site Implementations:** When you set up a site in either VoiceCheck or VoiceConsole, you must specify the time zone where that site is located. You must ensure that the same time zone is specified for a site in both applications. You are not required to specify the same site name; however, Honeywell recommends that you use the same site name for simplicity.

Once your sites are set up in both applications, you have to load a device profile for each site.

## Voice Process Software in Multi-Site Implementations

The Honeywell Voice Maintenance & Inspection Solution is designed to work with voice applications, Honeywell's voice process software.

When using multiple sites in VoiceCheck with voice application software, perform the following procedure:

1. In VoiceConsole, create a new task package and select to **Import New Task** from the **Name** drop-down list on the **Create Task Package: Select Task** page.
2. On the **Create Task Package: Set Sites** page on the **Task Settings** tab, enter the site for which you are creating the task package in the **SiteName** field.

If the **SiteName** field is not available, you cannot perform this process.

3. Complete the task package creation process.
4. Repeat the previous three steps for each site you are supporting.

## Database Servers

For best performance, Honeywell recommends that you install the VoiceCheck database on a separate server from the application, although a single server implementation is supported.

Honeywell recommends that you **not** install the VoiceCheck application and database and the VoiceConsole application and database all on a single server to avoid the single point of failure scenario.

## Clustered Environments

Honeywell Voice Maintenance & Inspection Solution can be installed on servers that are grouped for failover. Failover systems provide a fully redundant instance of each node, brought online only when its associated primary node fails.

The VoiceConsole application may also be configured on a server cluster for load balancing. See the VoiceConsole Implementation Guide for more details.

## NOTE

The solution does not support clusters for load balancing VoiceCheck at this time.

Clusters can be configured in three ways, as shown in the next sections.

- Single database with clustered application servers
- Single application server with a clustered database
- Clustered database and application servers

## Single Database with Clustered Application Servers

The VoiceCheck or VoiceConsole application is installed on multiple nodes of a clustered application server that communicates with a single instance of the associated database. Application clients communicate through a dispatcher.

Shown below, this configuration is setup during the VoiceCheck or VoiceConsole installation process.

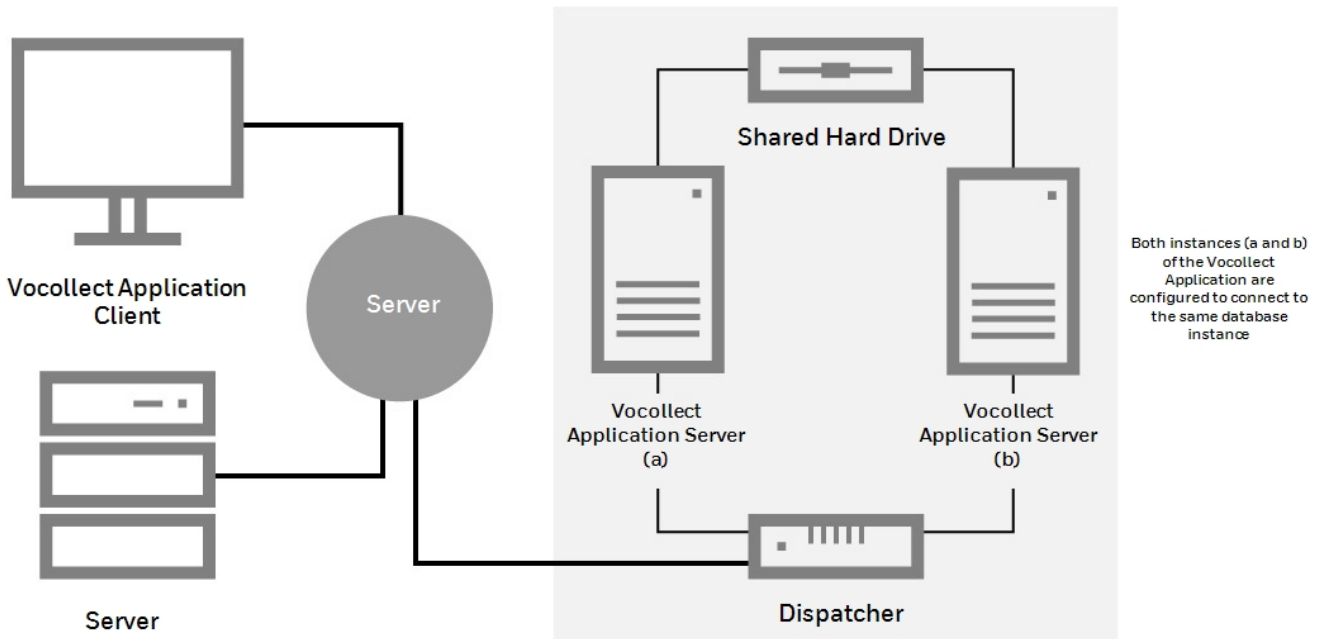

Single Database with Clustered Application Servers

The shared drive contains log files.

## Single Application Server with Clustered Database

VoiceCheck or VoiceConsole is installed on a single application server. It communicates with the associated database that has multiple nodes acting as a single interface for a common underlying database. This configuration is shown in the figure below.

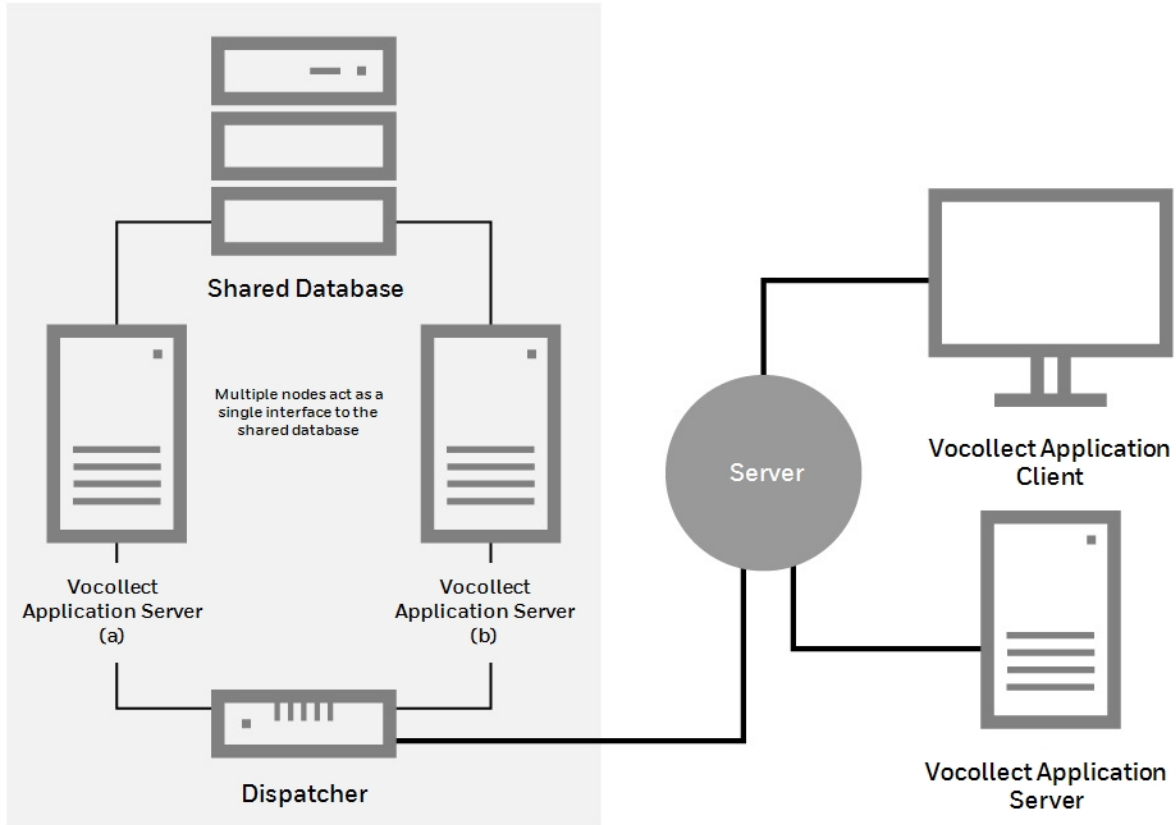

Single Application Server with Clustered Database

See your database documentation for setup information.

### Clustered Database and Application Servers

This configuration, shown in the figure below is a combination of the two scenarios described above.

In this scenario there are no single points of failure as both the application servers and the databases have some form of redundant response mechanism.

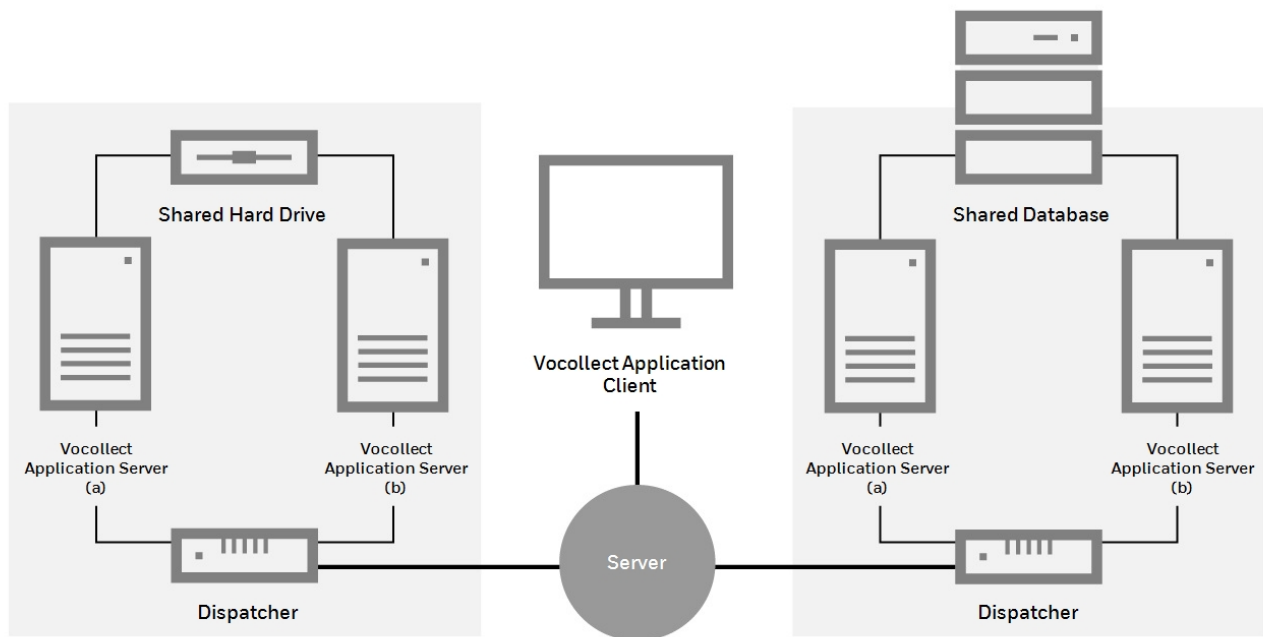

Both Database and Application Server Clustering

The shared drive contains the log files.

## Installing into a Clustered Environment

When installing the application on a Windows Server 2008, 2012, or 2016 clustered environment, you must perform the following steps:

1. Install the application on the first node. Note that you will need to provide some additional information when installing in a clustered environment.
2. Install the application on the next node. Most of the information is defaulted, based on the information provided in the first installation. In most cases, the information should not be changed when installing the second node.
3. Ensure that the active node has access to the shared storage location.

## Cluster Installation Steps for Windows Server

1. Select **Start > Administrative Tools**, and launch **Failover Cluster Manager**.
2. In the cluster configuration, highlight **Services and applications**, and select “Configure a Service or Application...” to start the appropriate wizard.
3. Select “Generic Service” from the **Select Service or Application** screen.
4. Select the **VocollectWebApplicationsVoiceCheck** service to configure, and choose an available name.
5. Assign the shared cluster disk to the service on the **Select Storage** screen.
6. Continue and finish the wizard; a new service configuration will appear under **Services and applications**.

7. Edit the properties of the **VocollectWebApplicationsVoiceCheck** service in the configuration to remove all Startup parameters.

## Installing to a Clustered Database

You can install VoiceCheck using a clustered database to house VoiceCheck data.

### JDBC Format

When you install to an Oracle RAC, you must specify the JDBC URL in the following format:

```
jdbc:oracle:thin:@(DESCRIPTION=(ADDRESS_LIST=(ADDRESS=(PROTOCOL=TCP)
(HOST=10.0.15.2)
(PORT=1542)) (ADDRESS=(PROTOCOL=TCP) (HOST=127.0.0.1) (PORT=1542))))
(CONNECT_DATA=(SERVICE_NAME=vlink.vocollect.int)))
```

Note how this format is very different from the format used to specify the JDBC URL for a single Oracle Enterprise install:

```
jdbc:oracle:thin:@127.0.0.1:1521:orcl
```

When installing VoiceCheck to use a clustered SQL Server database, you can point to the IP address of the cluster. Consult Microsoft online resources for more information about setting up a clustered or load-balanced SQL Server database.

## Network Configuration

The VoiceConsole server and its database and the VoiceCheck server and its database communicate constantly and should be installed with the fastest possible network connections between them.

Honeywell recommends that you install the servers and the databases on the same local network subnet.

## Network Protocols and Ports

VoiceConsole uses the following protocols.

- Internet Control Message Protocol (ICMP)
- Hypertext Transfer Protocol (HTTP)
- Hypertext Transfer Protocol with Secure Sockets Layer (HTTPS)

VoiceCheck uses the following protocols.

- Hypertext Transfer Protocol (HTTP)
- Hypertext Transfer Protocol with Secure Sockets Layer (HTTPS)
- Internet Protocol Suite (TCP/IP)
- Simple Mail Transport Protocol (SMTP)

VoiceConsole and VoiceCheck use the following ports by default. If these ports are not available, the next available ports in sequence are used. An advanced Apache Tomcat user can change the Tomcat-related ports after installation if necessary.

Port	Connection	Process	Comments
<b>VoiceConsole</b>			
9090	HTTP	Apache Tomcat Service	Used for proper startup and shutdown.
9091	HTTP	Apache Tomcat Comet API	The Comet API is used for asynchronous responses.
9443	HTTPS	Apache Tomcat Service	For inbound, browser-only, encryption.
9006	TCP/IP	Shutdown listener	
9010	TCP	AJP	AJP is a standard component of Apache Tomcat. It is a connector between Tomcat and its servlet container. It forwards the requests received from the browser to the servlet container. VoiceConsole uses it in its default configuration.
21050	TCP	Platform Management Service	Used for communication between VoiceConsole and VoiceCatalyst MI.
20155	UDP	Platform Management Service	Used for communication between VoiceConsole and VoiceCatalyst MI.
<b>VoiceCatalyst MI</b>			
80	HTTP	Mongoose lightweight web server	Default port used for serving device web pages when a display device is used with an inspection assignment. Port usage is limited to a specific device IP.
<b>VoiceCheck</b>			
9070	HTTP	Apache Tomcat Service	Used for proper startup and shutdown.
9071	HTTP	Apache Tomcat Service	If the standard port 9070 is not available, VoiceCheck looks for and uses the next available port.
9445	HTTPS	Apache Tomcat Service	Used for startup and shutdown in an SSL-secured environment.
9008	TCP/IP	Shutdown listener	
9012	TCP	AJP	AJP is a standard component of Apache Tomcat. It is a connector between Tomcat and its servlet container. It forwards the requests received from the browser to the servlet container. VoiceCheck uses it in its default configuration.

# VoiceCheck Upgrades

The VoiceCheck installation program can be used to perform a VoiceCheck upgrade as well. Before upgrading your existing version of VoiceCheck to a new version of the product, consider the following guidance.

## Backing Up and Re-creating Data

- You should back up your existing database before upgrading VoiceCheck to reduce the risk of data loss.
- You should preserve any customizations created on your existing system before beginning the upgrade to the new system. After the upgrade, you will need to restore these customizations.

## Database Upgrades

- You *cannot* upgrade from one database platform to another.
- You cannot use the upgrade installer to upgrade from one version of the database server to another. You should contact your database vendor.
- When an original VoiceCheck implementation uses a SQLServer database, the upgrade installer only recognizes a database schema name of "dbo." Therefore, if you have a VoiceCheck SQL Server database with a different schema, you will need to move all database tables to the dbo schema before upgrading.

### IMPORTANT

Honeywell strongly recommends that you back up your database before performing a VoiceCheck upgrade.

## Standard Upgrade

When running the upgrade installer:

- The installer detects whether a VoiceCheck version is already installed and uses this information to determine if an upgrade is possible.
- To upgrade a VoiceCheck database while installing the VoiceCheck application to a new server, you must first install the version of the application that corresponds with the existing database. During the installation (See See "Running the Installation Program" on page 11 for more information.) , enter the database settings so that the installer recognizes it.

With the legacy version fully installed, you can run the installer for the new version of the VoiceCheck application. It detects the existing database and upgrades the tables.

When an original VoiceCheck implementation uses a SQLServer database, the upgrade installer only recognizes a database schema name of "dbo." Therefore, if you have a



VoiceCheck SQL Server database with a different schema, you will need to move all database tables to the dbo schema before upgrading.

- In a clustered environment, you must delete the Cluster Resource associated with the **VocollectWebApplicationsVoiceCheck** service prior to initiating the upgrade. After the upgrade is complete on all nodes, add the Cluster Resource again.

Performing these steps will prevent application irregularities and failures because the Cluster Manager interferes with the upgrade process. During the upgrade, the installer stops the **VocollectWebApplicationsVoiceCheck** service then attempts to delete and recreate it. With a clustered service, however, the Cluster Manager attempts to restart the service causing Tomcat to restart; then it prevents the installer from deleting the service.

## Upgrading from a Standard Installation to a Clustered Environment

You may initially choose to perform a normal installation of VoiceCheck then decide after installing to migrate to a clustered environment. The process to complete this migration is described in this section.

If you want to use the same database as the original installation, you can uninstall VoiceCheck and opt to retain the database. An uninstall is only required if the original machine is intended to be part of the cluster. After the original application is uninstalled, you can install VoiceCheck to a clustered environment (see See "Installing into a Clustered Environment" on page 21 for more information.) and set VoiceCheck to use the existing database.

If you want to upgrade the database to a clustered database, uninstall the application and opt to retain the database. Follow the instructions provided by the database vendor (either Oracle or SQL Server) to upgrade the existing database to a clustered database. Then install VoiceCheck to a clustered environment (see See "Installing into a Clustered Environment" on page 21 for more information.). During this installation, point to the newly clustered VoiceCheck database.

## Post-Installation Steps

This section covers steps that must be or can be performed after installation, but before logging into the system or importing data into the system. Each step is described separately.

### Database Maintenance Plan

Honeywell recommends setting up regular database maintenance jobs to maintain optimal system performance.

- Schedule a database transaction log backup job to run. This should run regularly between full backups, typically once per day. For higher volume systems or if performance begins to degrade, schedule this job to run more frequently. It will not greatly impact performance of the system, but will improve it over a long duration of time.

- Rebuilding and reorganizing indexes regularly can increase performance in higher volume systems as the indexes on the tables may become fragmented. Schedule these jobs for SQL Server anywhere every 4 to 24 hours depending on your system. For Oracle, once a day should be sufficient

## Initial Database Connection Pool Settings

### Performance optimizations for installations supporting many devices

The connection pool for database connectivity can be adjusted, if necessary, in the **database.properties** file. The property and default value are:

```
Connection.maxPoolSize=20
```

Listed below are the recommended initial settings, which may be tuned as needed. Other factors may influence performance and require connection pool optimization, such as the number of client browsers that will be connected.

- For up to 1000 devices, maintain the default value of 20
- For 1001 to 1500 devices, set to 30
- For 1501 to 2000 devices, set to 40
- For 2001 to 2500 devices, set to 50
- For each additional 500 devices, add 10 connections

#### IMPORTANT

Warning: Increase the connection pool value only when absolutely necessary. Setting this value too high may cause database deadlocks.

## Apache Tomcat Performance Tuning

Depending on the number of device and browser connections expected, you may need to configure Tomcat.

In a text editor, open the server.xml file found in: <installation path>\tomcat\conf.

In the connector definitions (for HTTP and HTTPS) add or adjust the following properties.

- **maxThreads:** The number of actual worker threads should be in the range of 20% of total connections expected. The default is 150. If, for example, you expect a typical load of 1000 workers and 500 browsers, then set this property value to 20% of 1500, or 300.
- **acceptCount:** The number of threads that Tomcat will accept and hold until a worker thread is available. This value can be a large number close to total connections possible, but cannot exceed your machine's limitations in memory and threads allowed. Various operating systems are different; for example Windows 64-bit architecture allows a much larger threshold than Windows 32-bit systems.

Refer to Apache Tomcat documentation for other performance settings.

## Java Virtual Machine Settings

The default memory settings for the Tomcat application server Java Virtual Machine start at 256 MB and can grow up to 1024 MB. A setting of 1GB (1024 MB) is sufficient for most installations, but this will vary by the type and amount of data you intend to view unfiltered in your VoiceCheck system. To size this yourself, open the window in the application with the data you expect to view and check the **Mem Usage on Windows Task Manager**.

To change JVM settings in **Windows**, do the following:

1. Run the **VocollectWebApplicationsVoiceCheckw.exe** file in the **bin** folder of the **Tomcat** install under the **Vocollect** directory.
2. Click on the Java tab.
3. If using the internal transcription engine, add the following parameters in the Java Options input box.

```
-XX:MaxPermSize=512m
```

```
-XX:PermSize=256m
```

4. Change the Maximum Memory Pool setting to your desired value.

1024 MB recommended for small load implementations

2048 MB recommended for up to 2500 workers

Add an extra 1024 MB for the internal transcription engine

5. change the Initial Memory Pool setting as needed.

512 MB recommended for small load implementations

1024 MB recommended for up to 2500 workers

6. Set Thread stack size. (1024 KB recommended)
7. Click OK to save the settings and close the window.
8. Restart the webservice.

## First System Log On

Default roles and users are installed with the application.

The roles are:

- **Administrator:** granted full access to all administrative and general features of the application
- **Read-only:** granted read-only access to features (not granted access to any features that modify the system)

The users are:

- admin
- vocollect

Log in for the first time with the admin user name and **admin** as the password. This user will give you the appropriate access rights to start setting up the application.

Passwords must be changed after the first log in, and must adhere to the following password complexity requirements.

A minimum of 8 characters, including:

- 1 upper-case letter
- 1 lower-case letter
- 1 numeral or special character

New passwords must not match any of the last three user passwords.

Users will be locked out after three invalid login attempts and must wait 15 minutes to try again or contact their system administrator to unlock their account.

The **vocollect** user (password: voiceworks) is set up so that Honeywell field personnel can log into the application. This user can be deleted once a customer's system is completely set up. Honeywell recommends that the customer keeps it enabled until the system is fully implemented and the customer no longer needs the support from a Honeywell field representative.

Once you are logged into the application as admin, select **Administration > Users > Edit Your Profile** and change the password for the admin user to secure this login. On subsequent logins, use the new password for the admin user.

## Creating Additional Sites for Multi-Site Implementations

In order to support multiple sites, you must perform several steps in VoiceConsole and in VoiceCheck for the sites and their respective tasks, task packages, device profiles, users, and operators.

### Creating Multiple Sites in VoiceConsole

See your VoiceConsole documentation for more information.

#### 1. Create site-specific task files for each site

Enter specific site settings for the Honeywell Voice Maintenance & Inspection Solution voice application via the VoiceConsole interface. See *VoiceConsole Online Help* for detailed steps.

#### 2. Create a new site in VoiceConsole

##### HOW TO:

In the Administration section of the VoiceConsole GUI, navigate to **Sites** and click the **Create new site** action link.

### 3. Create a site-specific user for the new site

You need to create a site-specific administrator who can only view the site to which they are assigned.

#### HOW TO:

In the Administration section of the GUI, navigate to **Users** and click the **Create new user** action link.

Select **Administrator** in the **Roles** field.

Select the one site to which they are granted access in the **Sites** field.

### 4. Migrate operators from an existing VoiceConsole database

If implementing a new system, you may not need to perform the steps in this section. The steps below show how to migrate operator templates from an existing VoiceConsole implementation.

#### HOW TO:

In the **Operator Management** tab, navigate to **Operators**, select the operators you want to move, and click the **Move Operators > Move/Add selected operators to a site** action link.

From the **Destination Site** drop-down list, select the new site.

Select **Move the Operator to the selected site**

Complete the move, then confirm the move by selecting the new site from the **Site Information** drop-down list.

#### NOTE

You may need to verify that your license supports any operators that you add.

### 5. Import a task to the new site

#### HOW TO:

In the **Device Management** tab, navigate to **Tasks** and click the **Import Task** action link.

Complete all relevant fields, then select the site(s) at which this task will be available.

### 6. Create a task package for the new site

#### HOW TO:

In the **Device Management** tab, navigate to **Task Packages** and click the **Create new task package** action link.

#### NOTE

Every task package requires that the advanced settings be specified for each new site. Honeywell recommends that these settings be saved in a separate text document and then

asted in the advanced settings box at the time of creating the new task package.

## 7. Create a device profile for the new site

### HOW TO:

In the **Device Management** tab, navigate to **Device Profiles** and click the **Create new device profile** action link.

# Creating Multiple Sites in VoiceCheck

For multiple-site installations of VoiceCheck, you must create sites in addition to the singular default site.

## 1. Creating a new site in VoiceCheck

In the Administration section of the VoiceCheck GUI, navigate to **Sites** and click the **Create new site** action link.

## 2. Creating a site-specific user for the new site

In the Administration section of the GUI, navigate to **Users** and click the **Create new user** action link.

Select **Administrator** in the **Roles** field.

Select the one site to which they are granted access in the **Sites** field.

Select **Enabled** status.

### TIP

For other users who will have access to this site, you will need to go back to the original site and edit the users so that they have access to view or use this new site.

# Setting Up Application Security

Roles and users form the basis of application access control. The roles define privileges, and users can only perform the functions allowed by their assigned roles.

Default roles and users are installed with the application.

The roles are:

- **Administrator:** granted full access to all administrative and general features of the application
- **Read-only:** granted read-only access to features (not granted access to any features that modify the system)

The users are:

- admin
- vocollect

## Create Roles

**Roles** define what a user is allowed to do in the application. You can use the default roles or create roles of your own based on how you want to group and provide access to your users.

### HOW TO:

In the Administration section of the GUI, navigate to **Roles** and click the **Create new role** action link.

For each role, grant access to specific features by checking them.

When setting up roles, consider the following:

- If you grant a role permission to perform an action, such as Create User, make sure you grant that role permission to view the page where that action is accessed (in this case, you would grant the user permission to View Users).
- Determine roles based on groups of users that perform the same functions and name your roles according to those user groups.

For example, your shift managers may perform the same functions. Create a role called ShiftManagers and grant the appropriate rights to that role. Then, it is simple to determine which role to grant to users who are shift managers. In the future, this method will make it easy to determine which role to grant a user who has been newly hired for or promoted to a shift manager position.

#### NOTE

If you add a new role or change a role's privileges in a clustered implementation, you must reboot all the application servers in a cluster for that information to be updated in all the systems.

## Operators versus Users

In VoiceCheck, operator records and user accounts have different purposes.

- Operators are the technicians using Talkman devices to enter inspection results by speaking responses to voice prompts.
- Users are the technicians and administrators who log into the VoiceCheck graphical user interface (GUI) via a PC browser.

## Creating Operators

When you create an operator in VoiceCheck, you also create a user account automatically. These two accounts are linked because the technicians who perform voice-directed inspection

assignments must also be able to log on to the VoiceCheck application to review and submit completed steps.

You can create an operator and user from the **VoiceCheck > Operators** page.

#### **NOTE**

Operator IDs must be unique across VoiceCheck sites and must match operator IDs configured in VoiceConsole.

## **Creating Users**

You can set up a user account without an associated operator from the **Administration > Users** page. Create users only for administrators or managers who manage operators using the VoiceCheck GUI but do not use Talkman devices for voice entry.

## **Creating Operators and Users**

Every technician performing inspection assignments must have an associated operator in VoiceCheck that matches an operator defined in VoiceConsole. Technicians must **also** have a user account for logging into the VoiceCheck application.

You can setup both operator record and user account for each technician at the same time.

### **HOW TO:**

In the VoiceCheck tab of the GUI, navigate to **Operators** and click the **Create new operator** action link.

Complete both operator and user fields on the Create Operator page.

## **Create Users Only**

For application users who do not sign onto Talkman devices, you can create a user account that is not linked to an operator record.

Each application GUI **user** must have a unique username and must be granted at least one role.

### **HOW TO:**

In the Administration section of the GUI, navigate to **Users** and click the **Create new user** action link.

Create a separate user record for all non-operators who will use the application. When a user configures the application by adding or removing columns, applying filters, etc., these changes are saved for that user.

Refer to the VoiceCheck Online Help for more information about creating or editing roles and users.



## Create a Web Services User

If your assignment data imports from the host system, you must create a user for the host system to access VoiceCheck.

Assign the web services user a role that grants the Execute Web Services permission.

## Setting Up User Authentication

VoiceCheck can be set up to authenticate users who are signing into the system against a directory server such as LDAP or Active Directory.

1. Sign into **VoiceCheck**.
2. In the **Administration** tab, navigate to **System Configuration**.
3. Click the **Edit System Configuration** action link.
4. Select the **Authenticate users against directory server** option to enable users to log into the application using their directory server password. When selected, the following fields are displayed to configure associated parameters:

**Host:** Enter the hostname or IP address of the directory server.

**Port:** Enter the port on which the directory server is listening for connections.

**Search User Distinguished Name:** Enter the username (name of the user object and its container location within the directory) of a trusted user who has search permission on the directory server. This is not required because many LDAP servers support anonymous directory server binding.

**Search Base:** Enter the location within the directory server to begin a user search.

**Searchable Attribute:** Enter the attribute on the directory server that maps to the username of a user entered in the application. This may be uid, sn, or another attribute, depending on the directory server setup.

5. Once this information is specified, you can enter a username in the **Test User Name** field and click **Test Directory Server Connection Information** to test if the system is able to validate a user's username and password on the directory server.
6. Click **Save Changes**.

## Setting Up the Export Web Service

VoiceCheck uses a host system web service to post inspection assignment results. You must set the URL and, if required, turn on authentication in the user interface so that VoiceCheck can transmit data successfully.

### HOW TO:

In the Administration section of the GUI, navigate to **System Configuration** and click the **Edit System Configuration** action link.

Specify the connection parameters:

- **Service Endpoint:** Enter the URL for the web service endpoint for services provided by the host system. This is a required field.
- **Client Type:** Choose REST or SOAP web services for all data transmission between VoiceCheck to the host system.
- **Requires Authentication:** Check this option if access to the service endpoint requires a username and password, then supply the credentials in the appropriate fields.
- **Export Settings**

**Allow Auto Export:** Check the box to post results to the Host system as soon as an assignment is completed. Uncheck the box to require the user to submit assignments manually.

#### NOTE

Click **Manage exports** from the VoiceCheck tab to stop or start exporting. Exporting starts upon server reboot.

**Export mode:** Choose PUSH or PULL from the drop-down box. PUSH assignment exports send data to the host system when assignment data is ready. PULL assignment exports allow the host system to call the server to get the data. There are three REST web services available to PULL data from assignment exports, See "Data Transmission" on page 113 for more information..

## Setting Up a Transcription Server

### System Requirements

Honeywell recommends the following hardware and operating system requirements for systems to run a transcription server.

- 64-bit Windows Server 2012 or 64-bit Windows 7
- One 2.5Ghz CPU core
- 12GB RAM for the first transcription server instance plus an additional 4GB RAM for each additional transcription server instance

### Initial Setup

1. Download and install the latest version of Java 8 JRE using the default setup prompts.
2. [Download and install the Latest Tomcat 7](#). Allow the installer to create a Windows service. The Tomcat installation directory is `CATALINA_HOME`.
3. Unzip `TranscriptionServerRelease1.6.zip` to the location of your choice. This will create a `\transcription_server-1.6` folder. Refer to this folder as `TS_HOME`.

#### TIP

Honeywell recommends using the C:\ drive to save configuration time.

4. Add `%TS_HOME%\TranscriptionServer\WEB-INF\classes` to the system PATH environment variable.

5. Run the following installers included in the zip package:
  - vc\_redist\_x64.exe – C++ runtime
  - w\_ccompxe\_redist\_intel64\_2015.4.221.msi

## Transcription Models

A transcription server "model" refers to the combination of language and domain that a transcription server uses to transcribe the audio input. For example:

- You want to transcribe the recorded audio from US English news broadcast. The model would be US English for the language and News Broadcast for the domain.
- You want to transcribe the recorded audio from Latin Spanish Trucking. The model would be Latin Spanish for the language and Trucking for the domain.

## Industry Language Models

The following industry language models are currently available:

Domain	Language
Generic	English (US)
Generic	French Canadian
Generic	German
Generic	Latin American Spanish
Aerospace	English (US)
Trucking	English (US)
Trucking	French Canadian
Trucking	Latin American Spanish

## Configure the Transcription Server

You must configure a separate instance of the Transcription Server for each model that you want to support. You can also configure multiple instances of the server for a single model if you wish to increase the transcription throughput for that language. Complete the following steps to configure a model instance.

1. Create a context.xml file in %CATALINA\_HOME%\conf\Catalina\localhost. An example context.xml file for each language model is included in the distribution. If only a single transcription server instance is required, copy the example file as is. Otherwise, copy and rename the file. For example, copy enUS\_Generic\_1.6\_m2\_1.xml to enUS\_Generic\_1.6\_m2\_1.xml and enUS\_Generic\_1.6\_m2\_2.xml to configure multiple

instances.

#### **IMPORTANT**

Verify that the server meets the RAM requirement to run your requested number of instances.

2. If you did not unzip to `c:\` in step 3 above, edit each file and change the `docBase`, `modelFolder`, `uDataFolder`, and `waveFile` attributes to `TS_HOME`. For example, change `docBase="C:\TranscriptionServerReleaseR1.6"` to `docBase="<your TS_HOME location>"`
3. Restart the Tomcat service.
4. Verify that each instance is responding at the specified URL.

**Example:** Type `http://yourhostname/enUS_Generic_1.6_m1` into your browser, with `enUS_Generic_1.6_m2` being the name of the xml file you created in step 1. This assumes that you configured Tomcat to listen on port 80, which is the default. Otherwise, include the port you chose in your URL. You should get a response from the server that looks something like this:

```
<transcription>
<id>0</id>
<creationTimestamp>2016-10-13T14:57:10.519Z</creationTimestamp>
</transcription>
```

Next, configure your VoiceCheck server to connect to this Transcription Server as explained in See "Setting Up a Transcription Service Endpoint" below for more information..

## Setting Up a Transcription Service Endpoint

VoiceCheck includes a built-in transcription engine for transcribing VoiceNotes and memos. This engine supports only a basic, generic English vocabulary. The external server can support either English, German, French Canadian, or Spanish language transcriptions. Honeywell recommends you use an external transcription server with customizations for inspections that employ industry-specific vocabulary.

Separate transcription services may be available for your Honeywell Voice Maintenance & Inspection Solution. Ask your Honeywell representative for information.

If you install a custom transcription service on one or more servers, you must configure transcription service endpoint(s) so that VoiceCheck can properly submit and receive VoiceNotes via a REST web service.

#### **HOW TO:**

In the Administration section of the GUI, navigate to **System Configuration** and click the **Edit System Configuration** action link.

In the Transcription Service Settings, specify the service endpoint addresses.

- **Transcription Service Endpoints:** Enter each URL for the web service endpoint on a separate line. The web service connection may be secured (HTTPS) or not (HTTP).

To accommodate support of multiple languages and redirection based on language code, specify a locale in the URL and the VoiceCheck system will replace the token in the URL with the appropriate locale. If the token is not specified in the URL, all notes will go to that URL as before.

Example:

`http://TranscriptionServer:8089/transcription/{locale}_Generic_1.6_m1`

or

`http://TranscriptionServer:8089/{locale}/transcription`

#### IMPORTANT

To accommodate multiple languages, the transcription service for each language must either be running on the same host under different URLs, or the host names must contain the language code.

#### NOTE

If a VoiceNote or memo is being transcribed when a transcription server experiences a failure, that transcription will not complete until the server is restored. In an implementation with multiple transcription servers, the affected transcription does not fail over to another node.

## Setting Up Job Schedules

Schedules define when system processes should run. You can define a different schedule for each process. So, you may specify for one process to happen every five minutes, while another process may run once daily or weekly.

If several of these operations run simultaneously, the system-wide performance may diminish. You should consider scheduling some of these jobs (for example, the VoiceCheck data purge and external database maintenance jobs) to run during off hours or non-peak times.

Refer to the VoiceCheck Online Help for more detail about setting job schedules.

## Setting Up Email Notifications

You can set up VoiceCheck to email critical notifications to specific users.

#### HOW TO:

1. Assign all relevant users to a role that grants the ability to view notifications.
2. Add email addresses to the appropriate user accounts.
3. In the Administration section of the GUI, navigate to **System Configuration** and click the **Edit System Configuration** action link.
4. Enter the outgoing SMTP host information.
5. If the host requires authentication, enter the user name and password.

# Security Considerations

The Honeywell Voice Maintenance & Inspection Solution provides support for several methods of securing data communication. The following section shows where you can configure the solution to use secure methods of transmission.

## Options for Securing Your Implementation

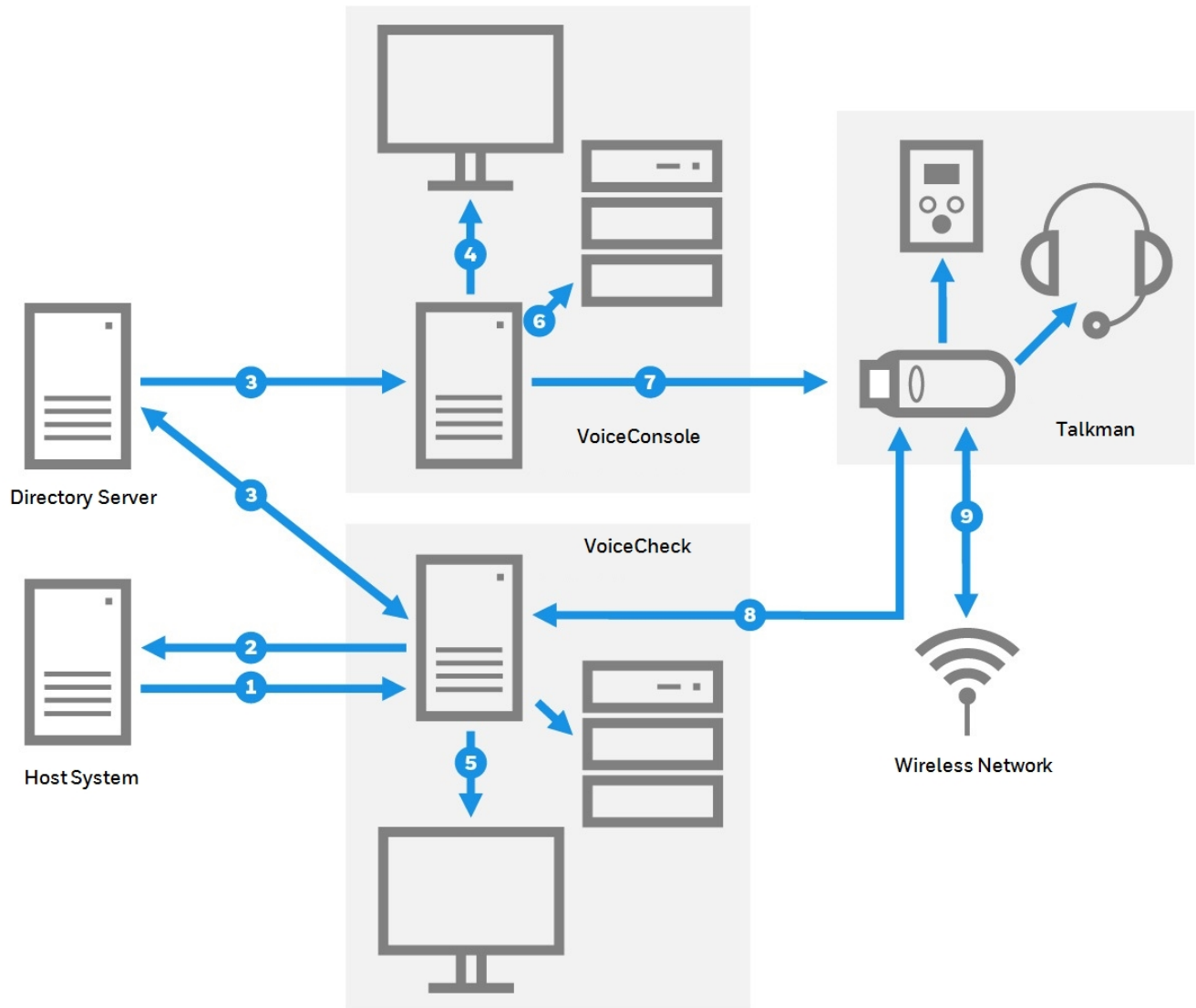

Voice Inspection Solution Security Options

1. **Assignment import** – an inbound web service transmission from the host system to VoiceCheck. Secure this data by configuring a server certificate on the VoiceCheck server and using an HTTPS inbound URL.
2. **Results export** – an outbound web service transmission from VoiceCheck to the host system. Secure this data by configuring a server certificate on the host system and

enabling HTTPS authentication in the **Post Assignment Results Web Service Settings** on the **System Configuration** page of the VoiceCheck GUI.

**Results import** – an inbound web service transmission from the host system to VoiceCheck. Secure this data by configuring a server certificate on the VoiceCheck server and using an HTTPS inbound URL.

3. **User authentication** – an option to use an existing directory server to authenticate VoiceConsole and VoiceCheck users. Set this option on the **System Configuration** pages of VoiceConsole and/or VoiceCheck.
4. **VoiceConsole web pages** – the GUI pages served from Apache Tomcat to the client browser. Secure the web pages by selecting the **Enable HTTPS Support** option during the VoiceConsole installation and entering your certificate keystore information in the Tomcat configuration file.
5. **VoiceCheck web pages** – the GUI pages served from Apache Tomcat to the client browser. Secure the web pages by selecting the **Enable HTTPS Support** option and entering your certificate keystore information during the VoiceCheck installation.
6. **VoiceConsole Embedded Database** – a *remote* connection to an embedded database can be configured to use SSL (Secure Socket Layer) encryption. Secure this remote connection by installing a certificate and modifying a number of properties in the Apache Tomcat database.properties file. This option is not available for Microsoft SQL Server or Oracle databases and is not necessary for databases deployed on the same physical machine as the application server. See the VoiceConsole Implementation Guide for details.
7. **VoiceConsole device communications** – wireless communications secured by WEP, WPA or WPA2 protocols, and data transmission from Talkman devices to VoiceConsole secured by HTTPS. Set both security options in **Device Profiles** in VoiceConsole.
8. **VoiceCheck device communications** – data transmission between Talkman devices and VoiceCheck secured by Transport Layer Security (TLS/SSL) encryption. Install a certificate on your VoiceCheck application server, then select this option when creating a **Task Package** in VoiceConsole.
9. **Wireless network authentication** – an option to deploy Extensible Authentication Protocol (EAP) to define data message formats for secure wireless communications among Honeywell solution components. Configure EAP on a site-wide basis by modifying the site in VoiceConsole.

Other communications shown in the graphic have security options that are not controlled within the Honeywell Voice Maintenance & Inspection Solution. The VoiceCheck database should be deployed on the same physical network segment as the VoiceCheck application server, so wired network security can protect this data transmission as well as data sent between VoiceConsole and its local database. The Talkman device connects to a display device using HTTP and to SRX3 headset via Bluetooth v5.

## Encryption and Authentication in VoiceConsole

VoiceConsole offers various options for securing the user interface, network communications, and device communications. Honeywell recommends combining encryption with a protocol that supports authentication methods to keep your networks secure.

- To secure web server communications, enable HTTPS during the installation, then obtain and install a certificate.

- To secure communication between VoiceConsole and Talkman devices, enable HTTPS in the device profile.
- To authenticate device connectivity on a wireless network, enable Extensible Authentication Protocol (EAP).
- To secure a wireless network with encryption, enable Wired Equivalent Privacy (WEP) or Wi-Fi Protected Access (WPA/PSK or WPA2/PSK).
- To verify users by authenticating logons against a directory service, enable LDAP support in System Configuration.

See the VoiceConsole Implementation Guide for more information.

## Encryption and Authentication in VoiceCheck

VoiceCheck has secure options for data transmission between the application server and the user interface, the Talkman devices, and the host system.

- To secure web server communications, obtain and install a certificate, then enable HTTPS during the installation.
- To secure device communications, enable TLS/SSL in the task package.
- To secure access to a SOAP or REST web service on the host system for data exports, enable HTTPS basic authentication in System Configuration. The password is encrypted and stored in the VoiceCheck database.
- To verify users by authenticating logons against a directory service, enable LDAP support in System Configuration.

## HTTPS and TLS/SSL

Hypertext Transfer Protocol Secure (HTTPS) is a networking protocol that secures web- or browser-based transactions over a network that is not secure. All HTTPS user connections are encrypted with digital certificates which tell the browser to use encryption to protect data transmissions.

This protection is effective only if the browser verifies a certificate as valid and issued by a trusted authority. Therefore, you must ensure that server certificates are installed correctly and the browsers used for VoiceConsole and VoiceCheck administration are configured to accept the certificates.

Transport Layer Security (TLS), commonly referred to as Secure Sockets Layer (SSL), is an encryption protocol that uses a public key infrastructure to secure data communications between a server and client. Like HTTPS, TLS/SSL requires that a certificate is installed on the server and a specific network port for secured transmissions to Talkman devices or a remote VoiceConsole embedded database.

If you are configuring your implementation for any of the HTTPS or SSL options, you will need the following components. See "HTTPS Certificate Installation" on page 46 for more information.

- Java keytool utility to create a certificate request
- A signed certificate, that includes all intermediate certificates if any exist



## Supported Authorities

Honeywell software supports the following certificate signing authorities.

- COMODO Certification Authority
- Cybertrust Educational CA
- DigiCert Global CA
- DigiCert High Assurance CA-3
- Entrust Certification Authority - L1B
- EssentialSSL CA
- GlobalSign Domain Validation CA
- GlobalSign Organization Validation CA
- Go Daddy Secure Certification Authority
- Microsoft Internet Authority
- Microsoft Secure Server Authority
- Network Solutions Certificate Authority
- Starfield Secure Certification Authority
- Thawte SGC CA
- VeriSign Class 3 Extended Validation SSL CA
- VeriSign Class 3 Extended Validation SSL SGC CA
- VeriSign Class 3 Secure Server CA
- VeriSign Class 3 Secure Server CA - G2
- [www.verisign.com/CPS](http://www.verisign.com/CPS) Incorp.by Ref. LIABILITY LTD.(c)97 VeriSign

## Failover and Recovery

In the event that VoiceCheck or another component of the Honeywell Voice Maintenance & Inspection Solution becomes unresponsive or shuts down unexpectedly, you may need to initiate data and application recovery procedures. A failover configuration could help prevent periods of system unavailability or data loss.

### Recovery Steps with no Automated Failover

If VoiceCheck becomes unresponsive, stop and restart the VoiceCheck service (or the Apache Tomcat server, also listed in services).

If this is unsuccessful, shut down and restart the machine hosting the server and verify that the VoiceCheck service successfully started. You should also verify that the database is up and available.

#### **WARNING**

If your VoiceCheck database service goes down or requires a restart, you *must* also stop the VoiceCheck application service. Start the application service again only after the database is fully up and running.

## Preventative Steps

### Backing Up, Restoring, and Maintaining the Database

VoiceCheck does not come with any built-in ability to back up the database. Honeywell strongly recommends that you schedule regular database backups. If a disaster occurs in which the database is corrupted or no longer available, you can restore a previous backup to use.

#### WARNING

If regular backups are not performed, the transaction log file will continue to grow and may eventually cause application problems.

### Connecting VoiceCheck to a Different Database

If you need to bring up a redundant database, ensure that all database information for the redundant database is the same as the original database. Then, perform the following steps to associate VoiceCheck with the new database.

1. On the server machine go to `<TOMCAT HOME>\webapps\VoiceCheck\classes`.
2. Open the file **database.properties** using a text editor.
3. Update the URL information in the following properties with the new host name of the redundant database.

```
hibernate.connection.url  
hibernate.connection.username  
hibernate.connection.password  
archive.hibernate.connection.url  
archive.hibernate.connection.username  
archive.hibernate.connection.password
```

4. Save the file.
5. Restart Apache Tomcat server.

#### TIP

The archive properties are not currently used, but you should update the URL information to maintain consistency.

#### IMPORTANT

The current passwords will be encrypted. Simply type the new passwords in plain text, and they will automatically be encrypted when the Tomcat server and VoiceCheck are restarted.

### Using a Secondary VoiceConsole Server

If your production VoiceConsole server becomes unavailable, you might have to switch temporarily to use a secondary or development implementation of VoiceConsole until the production machine is restored. As with VoiceCheck, you can create a failover configuration for

VoiceConsole. Install an instance of the VoiceConsole server on multiple machines that communicate with the same database. See the VoiceConsole Implementation Guide for more information.

In any scenario where a new VoiceConsole server is brought online, you have to load a new configuration file (device profile) to each Talkman A730x device so it can connect and communicate with a different instance of VoiceConsole. To deploy new configurations, you can load it on a single device via USB cable, then use TouchConfig to deploy the configuration to the rest of the devices. See VoiceConsole Online Help for information on loading profile through a cable.

## Reporting a Disaster

Be sure to report any incidents where your Honeywell Voice Maintenance & Inspection Solution application becomes unresponsive or shuts down unexpectedly. Send your logs to Honeywell. You can retrieve them from the user interface on the **Administration > Logs** page, and by default, the log files are stored in the following directory:

- `<InstallationDirectory>\logs`

## Uninstalling VoiceCheck

When you uninstall the system, you have the option to either keep or delete the data stored in the application.

The uninstall procedures below are applicable to systems that are installed either by the installation user interface or via the silent install process.

### Uninstalling a Non-Clustered Installation

For Windows systems where *only* VoiceCheck is installed:

1. Open the Windows **Start** menu.
2. Select **Settings > Control Panel**.
3. Double-click **Add or Remove Programs**.
4. Select Vocollect Enterprise Products in the list.
5. The uninstall application will start. Click **Uninstall**.

Or, for windows systems where *both* VoiceCheck and VoiceConsole are installed, run the uninstall application as an administrator. Find the application here:

`<InstallDirectory>/Uninstaller/uninstall.bat`

#### CAUTION

Do **not** run any uninstaller executable file (.exe) that may appear in the same or similar location. This file is only a part of the uninstall program and will not remove the application.

For a VoiceConsole Linux installation, execute the uninstall application found here:

`<InstallDirectory>/Uninstaller/uninstall.sh`

You may have to manually remove any desktop shortcuts to VoiceCheck after uninstalling the application.

## Uninstalling in a Clustered Environment

When you uninstall the application in a clustered or load-balanced environment, you must uninstall each node individually. Do not remove data until the last node is uninstalled. When you are prompted to remove data from the database, any additional nodes onto which VoiceCheck has been installed will no longer function correctly.

If you are uninstalling an instance of VoiceCheck that was installed in a clustered server environment, the uninstaller will not remove files from the shared files directory. To completely remove VoiceCheck, you must manually remove all files from the shared directory. The shared directory will contain:

- Some properties files that contain information that each installation node uses.
- Indexing (search-related index files)
- Log directory (optional)

## Solution Implementation Checklist

### Infrastructure

- Acquire server, workstation hardware
- Acquire Database software
- Order Talkman A700x series or Android devices
- Order SRX3 Wireless Headsets
- Order chargers
- Determine architecture model: decentralized/centralized, multi-server, multi-site
- Determine number of servers, server specifications
- Determine clustered server configuration if necessary
- Prepare network configuration and ports, network specifications
- Determine server locations, physical security
- Determine workstation locations

## VoiceConsole and Devices

- Plan security options
- Obtain and install HTTPS certificate if needed
- Create VoiceConsole database
- Install VoiceConsole
- Import license file
- Create sites
- Create roles, users, operators
- Configure wireless security, authentication if needed
- Configure email notifications if needed
- Import VoiceCatalyst MI
- Create device profile
- Import task
- Create task package
- Configure Talkman devices - device profile, task package
- Configure HTTPS certificate information in Tomcat if needed
- Hold technician training with paired devices, headsets

## VoiceCheck

- Plan security options
- Install HTTPS certificate if needed
- Create VoiceCheck database

## VoiceCheck

- Install VoiceCheck
- Create sites
- Create roles
- Create operators/users
- Configure authentication if needed
- Configure export web service connection
- Configure transcription service endpoints
- Set up job schedules
- Configure email notifications if needed
- Create VoiceForm
- Test web services integration between VoiceCheck and the host system

## HTTPS Certificate Installation

If you want to secure any VoiceConsole and/or VoiceCheck communications, you need to obtain and install one or more HTTPS certificates. The following steps can assist you with those tasks.

### Creating a Certificate Signing Request

To create a certificate, you must first create a certificate signing request.

1. Copy and paste the following command into a terminal session on the machine where the Java keytool is located. The command assumes that the Java keytool is installed on your server. Replace the variables that appear in bold with your own information.

```
keytool -genkey -alias tomcat -keyalg RSA -keysize 2048 -keystore  
<keystorePath>/keystore -dname "CN=<Domain name of server>, O=<Your Organization>,  
OU=<Organizational Unit>, L=<City>, ST=<State>, C=<Country>"
```

#### NOTE

If you are running this command on Windows, paste it into the command prompt and ensure the JDK bin folder is in your PATH environment.

2. Press Enter.
3. Enter a keystore password.
4. Press Enter.
5. Copy and paste the following command, replacing the bold variables with your information.

```
keytool -certreq -alias tomcat -file <csrPath>/<csrFileName>.csr -keystore  
<keystorePath>/keystore
```

6. Verify keystore password.
7. Press Enter and complete the creation.

The Java keytool utility creates your private key and certificate signing request as <keystorePath>/keystore and <csrPath>/<csrFileName>.csr.

## Getting a Certificate from a Certificate Authority

1. Send the files created by the Java keytool to a certificate signing authority. See See "Supported Authorities" on page 41 for more information..
2. Purchase a certificate.

## Installing the Certificate

### From a Certificate Authority

1. Place the certificate file you received from a certificate authority into the directory where your private key and certificate signing request were saved.
2. Run the following command, replacing the bold variables with your information. Keytool -import -trustcacerts -alias tomcat -file <certificateFileName>.p7b -keystore <keystorePath>/keystore
3. A confirmation of installation appears.

### Updating a Certificate

If you need to renew or change a certificate, request the new certificate with the same alias and for the same server name. You only need to reinstall the certificate. No additional steps are necessary.

## Configuring Tomcat with Keystore Information

Your VoiceConsole installation with HTTPS support requires a manual configuration of keystore information.

The VoiceCheck installation process includes keystore value entry but the following procedure is necessary for any keystore modifications following the installation.

1. In a text editor, open the Tomcat **server.xml** file that is found here: <installation path>\tomcat\conf.
2. Find the **Connector port** element for HTTPS in the file. This entry includes the keystore parameters.

- Update the location of the keystore file, the keystore password, and the keystore alias in the Tomcat connector definitions.

Example:

```
<Connector port="9445" maxHttpHeaderSize="8192" maxThreads="150"
minSpareThreads="25" maxSpareThreads="75" enableLookups="false"
disableUploadTimeout="true" acceptCount="100" scheme="https" secure="true"
SSLEnabled="true" clientAuth="false" sslProtocol="TLS" sslEnabledProtocols="TLSv1,
TLSv1.1, TLSv1.2" keystoreFile="C:\security\certtest.jks" keystorePass="talkman"
keyAlias="certtest" compression="on" compressionMinSize="1024"/>
```

**NOTE**  
 In the VoiceConsole file, there are two connector definitions that require the keystore information—the connector definition for HTTPS and the connector definition for COMET.

- Save the file.
- Restart the Tomcat service.
  - For VoiceConsole, the service is **VoiceConsole Service**.
  - For VoiceCheck, the service is **VoiceCheck Service**.
- Refresh your browser to view the application.

## VoiceCheck 1.8x Functionality

VoiceCheck 1.8x utilizes Honeywell Guided Work foundation. With this implementation, there are some changes in functionality that will be noticed in the Maintenance and Inspection app.

VoiceCheck 1.7x	VoiceCheck 1.8x
In Voice Mode, if the operator taps the Pause button on noise sample and then clicks device/app back button, "Disable Voice Recognition" popup is displayed.	"Disable Voice Recognition" popup is not implemented. Operator can enable/disable Voice Recognition before Login from the Settings page.
On the Section Summary screen, operator can directly select a step.	On the Section Summary screen, user can start section only with Ready button. Step selection is disabled.
For Record Memos and VoiceNotes, recording starts immediately as soon as the operator lands on the respective screens. (This is configuration based)	Operator has to speak "Ready" or click "Start Recording" button to start recording.
Error Messages are displayed on a separate screen.	Error Messages are displayed on the intent screen.
On Login screen, the label is Operator.	Label is UserID on Login screen.
Details Command works globally throughout the app.	Details command will only work on VoiceForm steps.
Retraining is done via Help screen on the Hamburger menu or by speaking the "I need help" command.	New voice Update Train implemented. Speak "Control Update Train" to retrain vocab words.



VoiceCheck 1.7x	VoiceCheck 1.8x
Test Boxes for Report Problem and Notes support 255 characters and a character count is displayed. The character counter color turns red and the count starts increasing in -ve once 255 limit is reached.	No character limit is set.
On Text tab on the Notes step, enter button saves the text note.	On Text tab on the Notes step, enter button is used for segregating between the current and new text note.
Only .bt2 template types are supported.	Support for new template types .SRXAND_2 has been implemented when training templates on a Honeywell Android device using SRX3 headsets.
Report Problem voice command is supported.	Report Problem voice command has been removed. Tap on Report Problem from the 3 dot menu.
Cancel button is on some screens across the app.	Cancel button is removed and added as an option on the 3-dot menu.
Float value recognizes 3 digits before the decimal place.	Float value recognizes 5 values before the decimal place.
Languages supported: English (US), Spanish (Latin America), Spanish (European), German, French (Canadian).	Languages supported: English (US), Japanese, Spanish (Latin America), Spanish (European), German, French (Canadian), French (French) , Dutch (Netherlands).
Mute functionality to mute and unmute the app.	To be implemented in future releases.
Operator Profile/Configuration screen.	To be implemented in future release.
Operator Specific Vocab Thresholds.	To be implemented in future release.
Operational Acuity Integration/Labor Tracking.	To be implemented in future release.
Configuration file for download.	To be implemented in future release.
Detailed Help .	To be implemented in future release.
No more button is disabled when there are no voice notes recorded/entered.	No more button is enabled when there are no voice notes. On trying to proceed to next screen without recording/entering text/voice notes an error message is displayed on the screen.
Spell tags not implemented.	Spell tags implemented.
One voice note at a time is reviewed at the end of assignment.	All voice notes are shown at once in case of review at the end of assignment.
Settings option.	Some options to be implemented in future release.



# USER OPTIONS

The Honeywell Voice Maintenance & Inspection Solution is designed to integrate with and support various IT infrastructures, databases, and operating systems. Depending on your system configuration, the hardware and software requirements may vary. Choose your configuration below.



# ANDROID SUPPORTED ENVIRONMENTS

## Supported Environments

<b>Android</b>	
<b>Operating System</b>	Android 11
<b>Languages</b>	English (US), Japanese, Spanish (Latin America), Spanish (European), German, French (Canadian), French (French) , Dutch (Netherlands).
<b>Devices</b>	The application will run on devices using Android 11. Refer to the list below for details.
<b>Headsets</b>	Honeywell SRX3

## Supported Honeywell Android Devices

- Honeywell CT40 with Android 11
- Honeywell CT40XP with Android 11
- Honeywell CT45 with Android 11
- Honeywell CT60 with Android 11
- Honeywell CT60XP with Android 11

## Supported Features

The following languages and features are currently supported in the Voice Inspection Android application.

Language	Feature		
	Trained Vocab	Spoken Long List	VoiceNotes / Memos
English	✓	✓	✓
Spanish (Latin American)	✓	✓	✓
Spanish (European)	✓	✓	✓
German	✓	✓	✓

Language	Feature		
	Trained Vocab	Spoken Long List	VoiceNotes / Memos
French (Canadian)	✓	✓	✓
French (France)	✓	✓	✓
Japanese	✓		
Dutch (Netherlands)	✓	✓	✓

**NOTE**

The Voice Inspection Android application does not currently support fractions or supervisor audio.

**Spoken Long List**

Users can train individual templates for list items using speaker independent functionality. Use the following guidelines when creating templates for spoken lists.

- List items may be 75 characters or less.
- Speaker-independent templates can only support up to two-digit numbers.
- List items with the following special characters can not be trained:

| ? < " : > + [ ] / ' \*

**TIP**

Use caution when using other special characters such as a comma (,) as they can be spoken or unspoken and users might not know the difference.

For example, the list item “red, blue” would generate a template so that the user could speak “red blue”. However, if the list item was “red , blue” (with an extra space before the comma), the user would need to speak “red comma blue” for the list item to be recognized.

**NOTE**

For performance reasons, a maximum of 20 untrained words per list is recommended and supported by the application.

**Solution Overview**

The Honeywell Voice Maintenance & Inspection Solution incorporates several components and applications that work together to deliver assignments to workers and record their results. The following diagram illustrates how the Honeywell Voice Maintenance & Inspection Solution works.

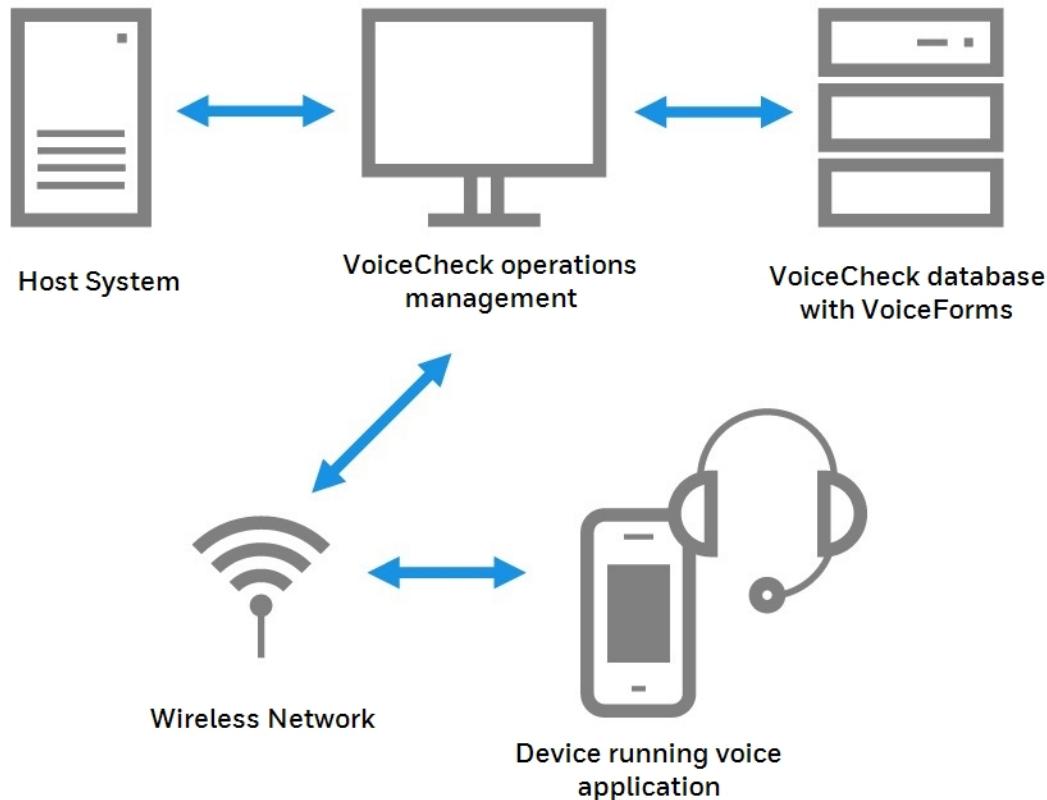

The Honeywell Voice Maintenance & Inspection Solution relies on data transmissions between a customer's host system, Honeywell VoiceCheck, and devices worn by technicians performing inspections.

## Component Functions

- **Host System:** The host system generates assignment data and sends this data via web interface messages to VoiceCheck. After technicians perform the inspections, the host system receives the results from VoiceCheck and updates its data records.
- **VoiceCheck:** The VoiceCheck middleware product uses assignment data along with voice prompts defined in a VoiceForm to create voice plans. It transmits the voice plans to Honeywell Talkman devices and receives technicians' response data from the devices. Finally, it exports the inspection results back to the host system. VoiceCheck provides a web-based graphical user interface for management and tracking of inspection assignments.
- **Android device running Voice Application:** Android device running the Voice Inspection Android application. Users can view each inspection step on an Android device.
  - **Voice Inspection Application:** This application runs on the Android device and controls all voice interactions between the technician and the assignment. The application translates incoming instructions into audible commands. It prompts

technicians to perform each step in an inspection assignment and converts technician responses into output data that is sent back to VoiceCheck

- **Wireless Headset:** The SRX3 headset pairs with Android devices. The headset and microphone enable a technician to hear and respond to assignment instructions in a variety of industrial environments.

## Data Mapping

Honeywell VoiceCheck provides a method to map data elements from a host system, identify and define specific work tasks, translate those tasks into voice prompts, prompt workers to perform the tasks and record results, and return the results to the host system.

If there is no host system present, VoiceCheck offers GUI pages for defining inspection plans and creating assignments. VoiceCheck uses a series of unique identifiers to perform the data tracking, merging, and parsing necessary to complete this process.

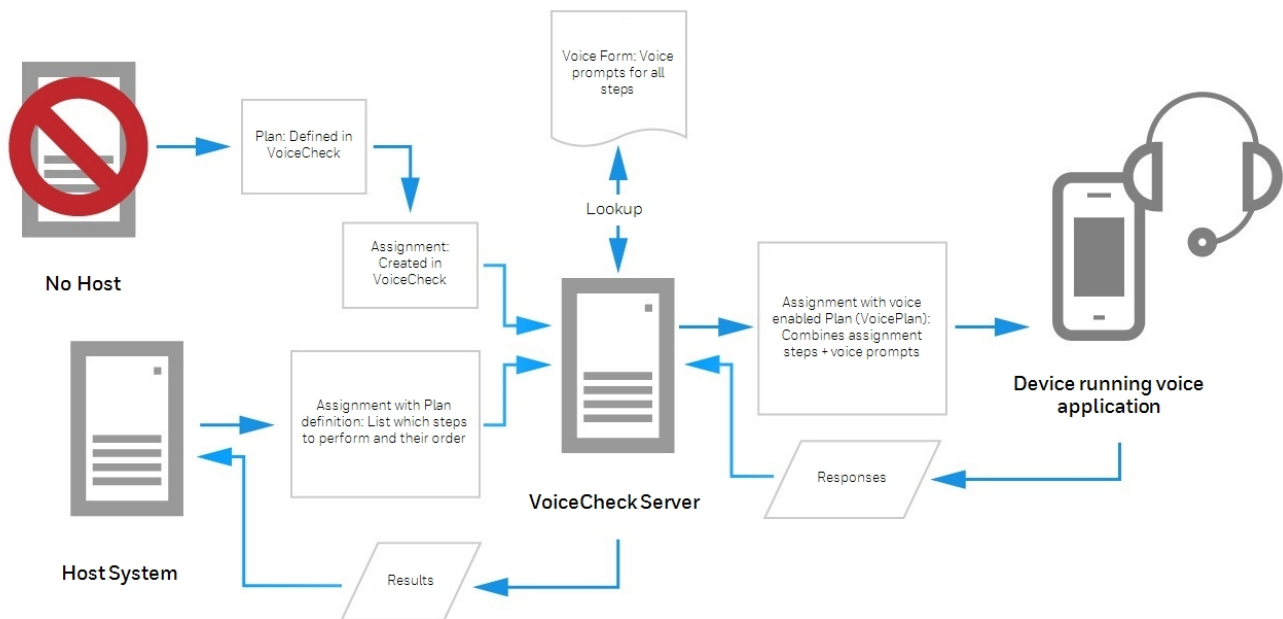

Inspection System Data Integration with or without a Host System

## Mobile App Settings

There are several ways to deploy the application to mobile devices.

You can also update Android devices to the latest VoiceCheck Android application from the **Mobile App Configuration** page under the **Inspection** tab following the instructions below:



## Upload the Application

If you have administrator or "update mobile app" rights, you can upload an application file that users can download and install to their devices. Follow these instructions to upload an APK file:

1. From the **Mobile Apps** page, under the **Update Mobile App** section, click the **Upload** button.
2. Navigate to the .apk file from your installation DVD or other file location and select it. You can also drag and drop the file to the upload area.
3. The App file, Size, Progress, and Actions fields will populate with information as the file uploads. A message will appear at the top of the screen when the apk file has uploaded successfully.
4. The file will appear in a table with its name and size after it has been successfully uploaded.

## Download and Install the Application

### Prerequisites

- Enable the setting "Allow installation of apps from sources other than the Google Play Store" on Android devices to allow installation of the application file.
- Enable "Download Mobile app" permissions for each user to be able to download the Android app.

Follow these instructions to download and install the application file to supported Android devices:

1. From the **Android Installation Instructions** section, click the link or scan the QR code using the device's QR barcode scanner. If a QR code does not appear on the **Mobile Apps** page, an apk file has not been successfully uploaded.
2. A login screen appears. Enter your VoiceCheck user ID and password. You must be an administrator or have Download Mobile app authorization.
3. Follow the instructions on your device to install the application.

## Mobile Device Management

### IMPORTANT

The feature described below is not available in the VoiceCheck 1.9 release. This feature is planned for a future release.

Using an in-house mobile device management (MDM) system, administrators can upload a JSON configuration file to end users of the mobile application. This way users do not need to configure a URL.

## Create Configuration File

### IMPORTANT

The feature described below is not available in the VoiceCheck 1.9 release. This feature is planned for a future release.

You can create a configuration file from scratch or you may follow these steps to save a configuration file from VoiceCheck:

1. Sign into the VoiceCheck server that users will connect to.
2. Enter the following URL in the browser: `<voicejCheckURL>/core/mobile/downloadAppFile.action`

### TIP

The `<voiceCheckURL>` can be copied from the **Mobile Apps** page in VoiceCheck.

3. Select **Download Configuration** from the download page. This will save the `InspectionAppConfig.json` configuration file.

### NOTE

The downloaded configuration file contains the User ID that was signed in when the file was downloaded. Change the UserID if appropriate.

## Upload Configuration File

### IMPORTANT

The feature described below is not available in the VoiceCheck 1.9 release. This feature is planned for a future release.

Upload `InspectionAppConfig.json` to each device's internal storage **/Download** folder. For Honeywell devices this is `/root/sdcard/Download`.

The format of the configuration file should be in the following JSON format:

```
{"operatorId": "<userID>", "server": "<serverURL>"}
```

Where `<userID>` is a specific user ID or default token and `<serverURL>` is the full server URL for the VoiceCheck server.

# Headset and Android Device Pairing

## SRX3 Headset Pairing

After an SRX3 headset enters low or high power pairing mode, it is available to accept a pairing initiated by a Bluetooth-enabled device. These pairings can be accomplished using a variety of methods:

### Touch Pair the SRX3 Headset Using Near Field Communication (NFC)

The SRX3 enters pairing mode as soon as it is powered on.

If the SRX3 headset is not connected, it powers off after 10 minutes in the disconnected state to preserve battery life.

If the USB cable is attached to charge the internal battery, the SRX3 headset disconnects (if connected) and battery charging begins.

1. Make sure the SRX3 headset is on and is in pairing mode (the LED is solid green).
2. Locate the NFC tag in the headset eModule under the Power button.
3. Hold the NFC tag on the eModule close to the back of the device. It may be necessary to move the eModule up and down the back of the device to get the NFC tag close to the NFC radio in the handheld device.

### Screen-Based Pairing

Screen-based pairing is the preferred method for pairing an SRX3 headset with a handheld wireless device or PC. This method allows the user to pick a specific headset from a list of available headset Bluetooth addresses displayed on a screen, and eliminates the problem of unwanted cross pairing. Auto and manual pairing processes are not available in screen-based pairing.

Prerequisites:

- The headset is powered off.
  - The device is not charging, and there is no wired headset connected to it.
  - The device is in sleep mode – not in use running an application.
  - The device is Bluetooth ready with Bluetooth connection features enabled.
1. Turn on the SRX3 headset. The SRX3 headset starts up in low power pairing mode.

#### TIP

Some handheld devices may require the headset to be in high power pairing mode in order to be discovered in the device's pairing inquiry. To change to high power pairing mode, press and release the Plus (+) and Minus (-) buttons on the headset while it is in low power pairing mode.

2. Initiate the pairing inquiry from the master device by pressing or clicking the appropriate button on the screen or device.
3. Hold the headset and wireless device so they are within six inches of each other but not touching.
4. Select the ID number of the headset you want to use from the **Select SRX Headset** list on the screen.
5. Tap, click, or press the appropriate button on the screen or device to create the pairing.

The device briefly displays that the device attempts to connect to the headset . Once the headset connects, three tones play in the headset, the SRX Headset Status displays as Connected. The pairing confirmation step is skipped because the pairing was specified by the user.

6. Press the Play/Pause button to begin working.

## SRX3 Quick Reference



Action	Result
Power on	LED solid green High double beep
Power off	LED turns off Low double beep
Change volume	Press Volume Up or Volume Down
Paired/connected	LED blue flash 3 connect tones
Paired/not connected	LED green flash 3 disconnect tones
Mute	Flip microphone up to mute. (SRX3 only)

## Flip-to-Mute

Flip-to-mute is supported for the SRX3 headset running the Android app, however the SRX3 firmware must be 4.07 or greater for full support.

- With firmware 4.07, flipping the microphone to the vertical position mutes the microphone and places the app in standby.
- With firmware prior to 4.07, flipping the microphone to the vertical position places the app in standby, but the microphone is not muted.

## Getting Started

This page contains information to help you get started with the Voice Inspection Android application.

## Initial Setup

Operators are instructed to "Please keep quiet for a few seconds" as the application gathers background noise samples to help improve voice recognition. If they have not done so, the operator will also be instructed to train voice templates required by the application. This operation preparation is only required once for the running of the application.

## Training Voice Templates

All new technicians must train their voice templates (all the common words that they will use in the voice-directed workflow) in order to perform an inspection with the Honeywell Voice Maintenance & Inspection Solution. The RapidStart application automatically guides technicians through the template training process.

### HOW TO:

Have each technician put on his or her headset and turn on the paired device.

**Device:** "Please keep quiet for a few seconds."

**Device:** "Please say zero."

**Tech:** "Zero."

**Device:** "One."

**Tech:** "One."

**Device:** "Two."

**Tech:** "Two."

**Device:** "Please say the following words..."

The device prompts each word or phrase at least four times, and the technicians should repeat the prompts naturally. At the end of the training, the device says "Creating voice templates. Please wait." Finally, the device says "Finished creating voice templates," and it goes to sleep.

## Login Screen

**Operator:** Your operator ID as set up in VoiceCheck.

**Password:** Your password as set up in VoiceCheck.

## Settings

Android application settings can be accessed from the left-side hamburger menu. Some properties can not be modified while logged in. The following settings are available in the VoiceCheck Android application.

## Maintenance

### IMPORTANT

The feature described below is not available in the VoiceCheck 1.9 release. This feature is planned for a future release.

**Clear assignment data:** This will clear any assignments and collected data that has not yet been sent to the server. USE WITH CAUTION. Default is off.

## Application Language

The language that the application runs in. Touch the box to view available languages and touch a language to select it. Only supported languages will be shown. The application must be restarted after changing the language.

## Application Settings

Current application scheme is set to microservices by default. This setting must be changed to FileBased to upload the license on the application.

## Voice & Audio Settings

The user can:

- Configure text to speech speed
- Turn recognition on or off
- Manage templates
- Enable or disable on-screen voice captioning.

## Inspection Settings

The URL for the VoiceCheck server you want the application to connect to.

## About

**Device ID:** The device's serial number.

**Version:** The version of VoiceCheck that is installed on the device.

## Profile

The profile view shows information about the operator and the device. The following information is available from the Profile screen:

**Operator:** The currently signed in operator or the last operator that was signed in.

**Operator Name:** The full name of the operator as specified on the server.

## Text to Speech

**Speed:** The speed that text will be spoken within the application.

**Play Sample Prompt:** Press this button to hear the speed of spoken text as set on the Speed bar.

## Assignments Loaded

**Pending Data:** A list of assignments that have been loaded but are still pending completion. Assignments displayed show the Work ID, number of steps completed, and total steps.

## Starting Work

To start a work assignment:

1. At the Login screen, enter your **Operator** and **Password**.
2. Tap **Ready**. The Select Work screen appears.  
From here you can create a new assignment, view assigned assignments, or view all available assignments.

## Select an Existing Assignment

1. From the **Select Work** screen, tap Assigned or Available to view your assigned or available assignments.
2. Tap your desired assignment on the screen or respond "yes" or "no" to each spoken assignment ID.
3. The start work screen will appear after you have selected an assignment.

### TIP

Say or tap **Cancel** if your desired assignment is not shown. This will return you to the **Select Work** screen.

## Create a New Assignment

1. Tap "Create" and confirm.
2. Select a plan from the Plan Selection screen.
3. Enter the full **Work ID** of the new assignment to be created, then say or tap Ready.
4. The start work screen appears.

### TIP

Say "options" at any point in the workflow and respond "yes" or "no" to move through the prompts.





## Supported Environments

### VoiceCheck

<b>Operating System</b>	<ul style="list-style-type: none"> <li>• Microsoft Windows Server 2022</li> <li>• Microsoft Windows Server 2019</li> </ul>
<b>Database</b>	<ul style="list-style-type: none"> <li>• Microsoft SQL Server 2019</li> <li>• Microsoft SQL Server 2017</li> <li>• Oracle 19c</li> </ul>
<b>Web Browser</b>	<ul style="list-style-type: none"> <li>• Google Chrome 31.x and newer</li> <li>• Mozilla Firefox v. 20.0 and newer</li> </ul>
<b>Language</b>	English (US), Japanese, Spanish (Latin America), Spanish (European), German, French (Canadian)

## Supported Features

The following features are supported by the following languages for the Talkman A700x.

Language	Feature		
	Trained Vocab	Spoken Long List	VoiceNote/Memos
English	✓	✓	✓
Spanish (Latin American)	✓	✓	✓
Spanish (European)			
German	✓	✓	✓
French (Canadian)	✓	✓	✓

## Spoken Long List

Users can train individual templates for list items using speaker independent functionality. Use the following guidelines when creating templates for spoken lists.

- List items may be 75 characters or less.
- Speaker-independent templates can only support up to two-digit numbers.
- List items with the following special characters can not be trained:

| ? < " : > + [ ] / ' \*

**TIP**

Use caution when using other special characters such as a comma (,) as they can be spoken or unspoken and users might not know the difference.

For example, the list item “red, blue” would generate a template so that the user could speak “red blue”. However, if the list item was “red , blue” (with an extra space before the comma), the user would need to speak “red comma blue” for the list item to be recognized.

## Solution Overview

The Honeywell Voice Maintenance & Inspection Solution incorporates several components and applications that work together to deliver assignments to workers and record their results. The following diagram illustrates how the Honeywell Voice Maintenance & Inspection Solution works.

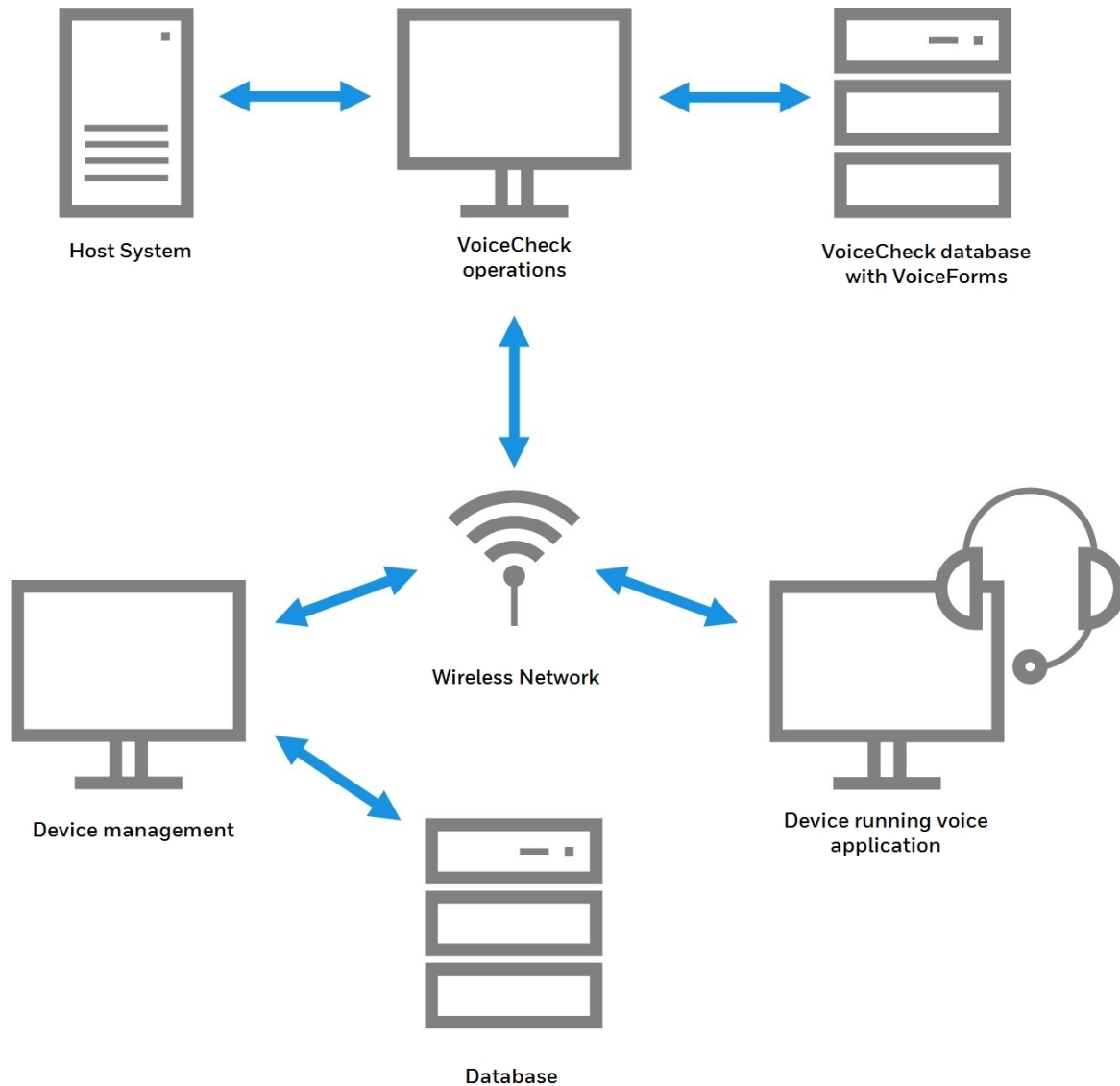

The Honeywell Voice Maintenance & Inspection Solution relies on data transmissions between a customer's host system, Honeywell VoiceCheck, and devices worn by technicians performing inspections.

## Component Functions

- **Host System:** The host system generates assignment data and sends this data via web interface messages to VoiceCheck. After technicians perform the inspections, the host system receives the results from VoiceCheck and updates its data records.
- **Honeywell VoiceCheck:** The VoiceCheck middleware product uses assignment data along with voice prompts defined in a VoiceForm to create voice plans. It transmits the voice plans to Honeywell Talkman devices and receives technicians' response data from the devices. Finally, it exports the inspection results back to the host system.

VoiceCheck provides a web-based graphical user interface for management and tracking of inspection assignments.

- **Honeywell VoiceConsole:** Administrators use VoiceConsole to configure and manage Talkman devices.
- **Honeywell Talkman A730x Device:** The Talkman A730x runs VoiceCatalyst MI voice software which translates incoming instructions into audible commands. It prompts technicians to perform each step in an inspection assignment and converts technician responses into output data that is sent back to VoiceCheck.
- **Inspection Voice Application:** The voice application runs on the Talkman A730x and controls all voice interactions between the technician and the assignment.
- **Honeywell Wireless Headset:** The SRX3 Headsets pair with a Talkman A730x device. The headset and microphone enable a technician to hear and respond to assignment instructions in a variety of industrial environments.
- **Display Device:** Users can view each inspection step on mobile devices or PCs running supported browsers.

## Data Mapping

Vocollect VoiceCheck provides a method to map data elements from a host system, identify and define specific work tasks, translate those tasks into voice prompts, prompt workers to perform the tasks and record results, and return the results to the host system.

If there is no host system present, VoiceCheck offers GUI pages for defining inspection plans and creating assignments.

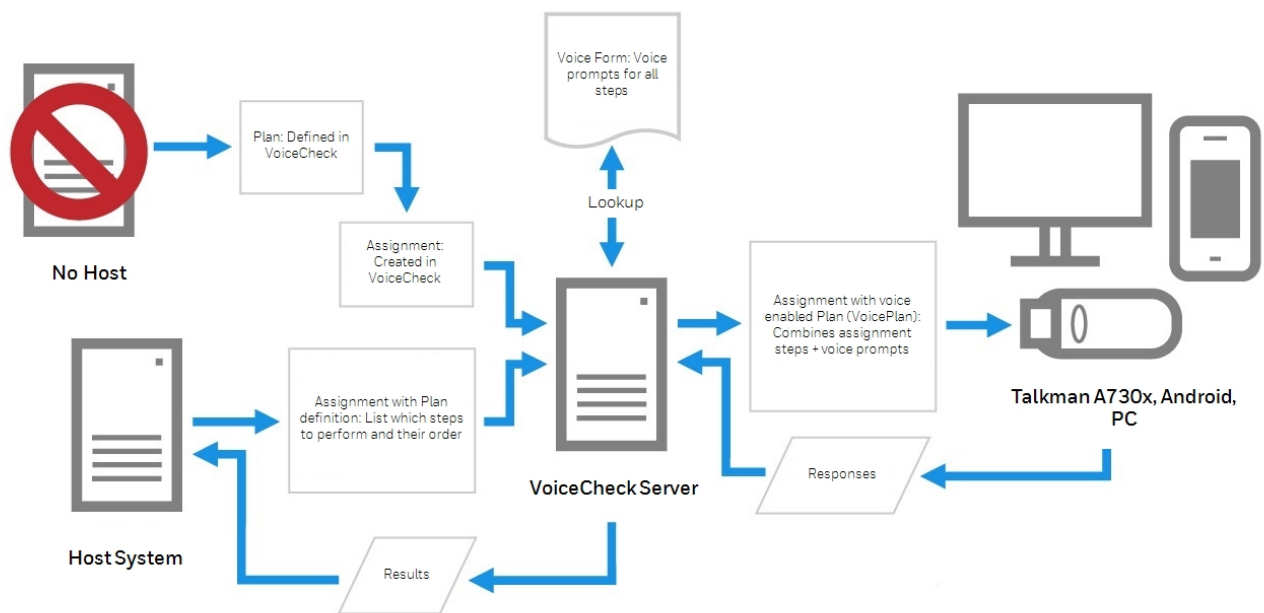

Inspection System Data Integration with or without a Host System

VoiceCheck uses a series of unique identifiers to perform the data tracking, merging, and parsing necessary to complete this process.

# Technician Training

With *VoiceConsole* and devices configured, your technicians can start training their voice templates and learning the basics of how to use Honeywell equipment and Honeywell voice applications.

## Headset and Talkman Pairing

### SRX3 Headset Pairing

After an SRX3 headset enters low or high power pairing mode, it is available to accept a pairing initiated by a Bluetooth-enabled device. These pairings can be accomplished using a variety of methods:

#### Auto Pair an SRX3 Headset with a Talkman Device

Prerequisites:

- The headset is powered off.
- There is no wired headset connected to the Talkman device.
- The Talkman device is Bluetooth ready with Bluetooth connection features enabled.

#### **IMPORTANT**

An unpaired device will constantly search for wireless headsets while in auto pairing mode. Do not leave an auto pair-enabled device unpaired and powered on because the search will drain the battery.

1. Reboot the Talkman device or remove it from a charger to initiate a scan for headsets.
2. Turn on the headset.

The headset will remain in pairing mode for ten minutes. If not paired within ten minutes, it powers off.

3. Hold the headset and Talkman device so they are within six inches of each other but not touching.

The blue LED indicator on the Talkman device turns on, may flash a few times, and then remains lit. After 20 to 30 seconds, the headset beeps three ascending tones and its LED indicator flashes blue. These indicators confirm that a pairing has completed.

4. Put on the headset. You will hear the headset repeat the serial number of the Talkman device to which it is paired.
5. Verify that the number matches the serial number on the Talkman device.

If you need to attempt the pairing again, re-enter pairing mode by pressing and releasing the Plus (+) and Minus (-) buttons on the headset control panel.

6. Press the Play/Pause button on the Talkman device to confirm the number.
7. Press the Play/Pause button again to begin working.

## Pair an SRX3 Headset with a Talkman Device Using TouchConnect



The A700x device can use TouchConnect to connect to an SRX3 Wireless Headset when:

- the A700x device is running VoiceCatalyst
- Bluetooth is enabled
- the device is sleeping (not running a task)
- a wired headset is not attached or a wireless headset is not actively connected to the device
- the parameter **SRXHeadsetEnable** is set to 1 (Enabled), the default
- the parameter **SrxAutoPairEnable** is set to 0 (Disabled), the default

For best performance when using an SRX3 headset with a Talkman A700x device, use the latest SRX3 software version. Obtain the latest headset software from your Honeywell portal or reseller and use the Honeywell Accessory Update Utility to upgrade your SRX3 headset.

### NOTE

Data sent through near field communication (NFC) is not encrypted nor does it follow any specific safety protocol. This is because the transfer occurs over such a short range that it is extremely unlikely that the data could be intercepted.

1. Turn on the SRX3 headset.
2. If the headset's LED is blinking blue, it is currently paired to a device. Clear the pairing by pressing the + and - buttons simultaneously on the SRX3 headset.
3. **If you are sharing headsets at your site:**  
You must first obtain the operator ID by reading the headband:
  - Touch area of the SRX3 t-bar (headband) with the  symbol to center of the raised oval on the side of the device with the , until the device state (ring) indicator blinks green. This associates the operator's headband to the device enabling VoiceConsole to recognize the operator.

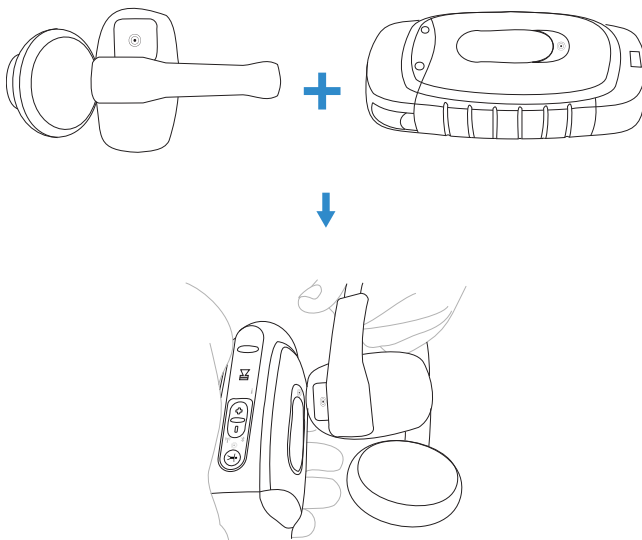

- Touch the side of the A700x device that has the  symbol and the oval area of the SRX3's keypad section together, aligning the ovals on each and holding them together steadily, until the device state (ring) indicator blinks green. Note that there is a 30-second timeout after a headband is recognized in step one. You must pair the electronics module within 30 seconds from associating the headband for full functionality.

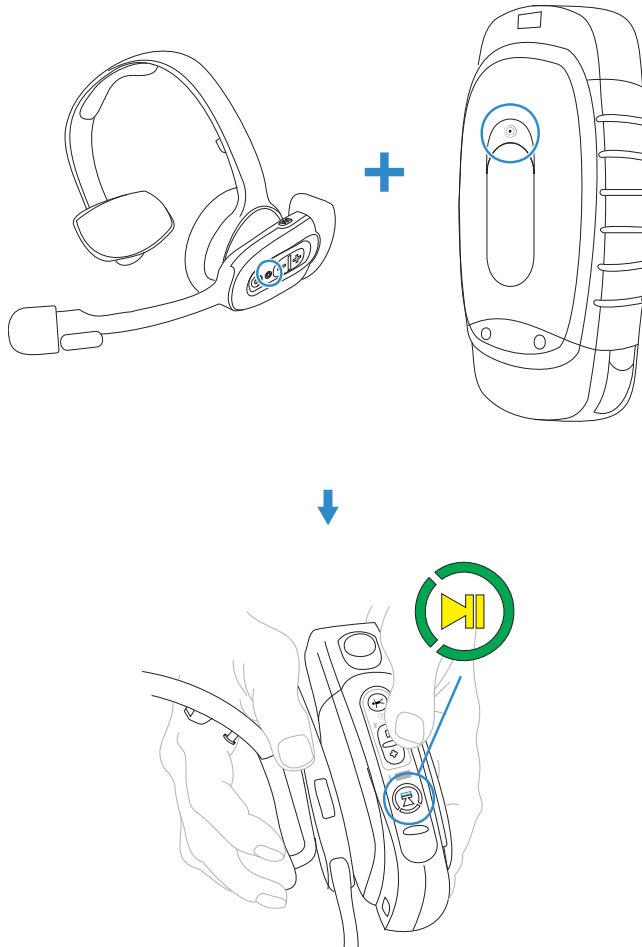

**TIP**

If the device state indicator blinks red, the NFC read was not successful, and you should attempt to perform the read again.

**4. If you are not sharing headsets at your site:**

You only need to pair the device to the SRX3 electronics module:

- Touch the side of the A700x device that has the  symbol and the oval area of the SRX3's keypad section together, aligning the ovals on each and holding them

together steadily, until the device state (ring) indicator blinks green.

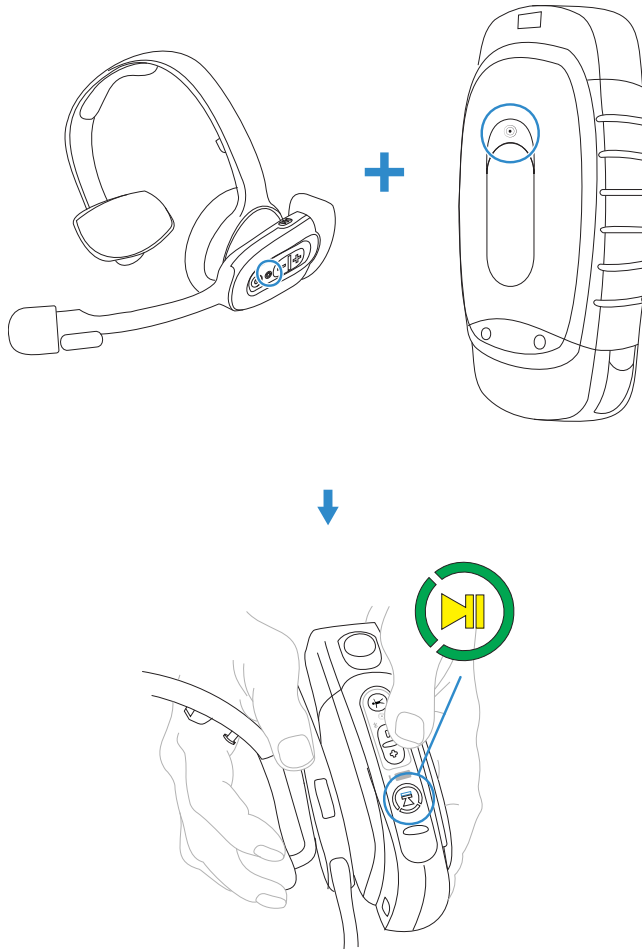

**TIP**

If the device state indicator blinks red, the NFC read was not successful, and you should attempt to perform the read again.

5. When the device starts the task, VoiceConsole recognizes the pairing.

## Manually Pair an SRX3 Headset with a Talkman Device

Prerequisites:

- The headset is powered off.
- The Talkman device is not in a charger, and there is no wired headset connected to it.
- The Talkman device is in sleep mode — not in use running a task or voice application. Its green LED indicator is flashing. If the LED is solid green, press the Play/Pause button.
- The Talkman device is Bluetooth ready with Bluetooth connection features enabled.

1. Turn on the headset.

The LED indicator is solid green. The headset remains in pairing mode for ten minutes then powers off.



2. Press and hold the Plus (+) and Minus (-) buttons on the Talkman device for two seconds to manually initiate a search for wireless headsets.
3. Immediately hold the headset and device so they are within six inches of each other but not touching.

The blue LED indicator on the Talkman device turns on, may flash a few times, and then remains lit. After 20 to 30 seconds, the headset beeps three ascending tones and its LED indicator flashes blue. These indicators confirm that a pairing has completed.

4. Put on the headset. You will hear the headset repeat the serial number of the Talkman device to which it is paired.
5. Verify that the number matches the serial number on the Talkman device.

If you need to attempt the pairing again, re-enter pairing mode by press the Plus (+) and Minus (-) buttons on the Talkman device again.

6. Press the Play/Pause button on the Talkman device to confirm the number.
7. Press the Play/Pause button again to begin working.

## SRX3 Quick Reference



Action	Result
Power on	LED solid green High double beep
Power off	LED turns off Low double beep
Change volume	Press Volume Up or Volume Down
Paired/connected	LED blue flash 3 connect tones
Paired/not connected	LED green flash 3 disconnect tones
Mute	Flip microphone up to mute. (SRX3 only)

## Training on Honeywell Voice and Devices

The Honeywell RapidStart VoiceApplication is a self-guided training system for technicians who are new to voice inspections or who need some refresher instruction. RapidStart uses audio and video cues to teach technicians how to wear and use Honeywell equipment and how to use Honeywell voice solutions. The application also steps them through creating their voice templates.

The RapidStart training requires a Talkman device and any browser-based device with a display, such as a tablet or smart phone.

### NOTE

RapidStart training is only available for Talkman devices.

## Setting Up RapidStart

1. Import the RapidStart task file, **RapidStart<version>.vad**, into VoiceConsole.
2. Create a task package from the RapidStart task.
3. In VoiceConsole, create the new operator and associate the task package for the operator's regular inspection work.
4. Load the training task to a Talkman device.
5. Load the operator to the Talkman device.
6. On the display device, access the main browser page of the Talkman device.

Typically, connect the display device to the same network as the Talkman device and enter the IP address (or the hostname as vv-deviceserialnumber) of the Talkman device in the browser's address bar.

7. Connect a headset to the Talkman device.
8. Give the devices and headset to the technician. The technician begins training by pushing the Play/Pause button.

See VoiceConsole Implementation Guide for more information on RapidStart.

## Training Voice Templates

All new technicians must train their voice templates (all the common words that they will use in the voice-directed workflow) in order to perform an inspection with the Honeywell Voice Maintenance & Inspection Solution. The RapidStart application automatically guides technicians through the template training process.

### HOW TO:

Have each technician put on his or her headset and turn on the paired device.

**Device:** "Please keep quiet for a few seconds."

**Device:** "Please say zero."

**Tech:** "Zero."

**Device:** "One."

**Tech:** "One."

**Device:** "Two."

**Tech:** "Two."

**Device:** "Please say the following words..."

The device prompts each word or phrase at least four times, and the technicians should repeat the prompts naturally. At the end of the training, the device says "Creating voice templates. Please wait." Finally, the device says "Finished creating voice templates," and it goes to sleep.

# Talkman Reference Guide

## Talkman A730x Quick Reference

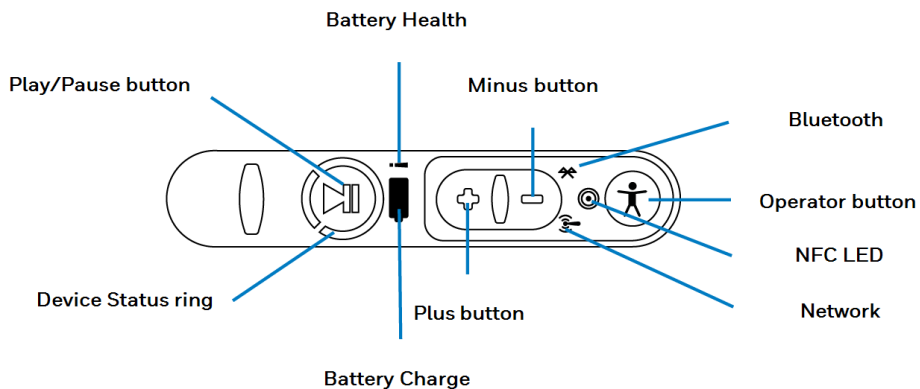

### Talkman A730x LEDs



Solid green segment

On, working properly

Pulsing green segment

Sleep (play/pause to wake)



Solid green ring

Charge complete

Fast blink green ring

TouchConnect in progress



Solid yellow ring

Charge in progress

Rotating yellow ring

Start up or load software



Rotating red ring

Shut down

Fast blink red ring

In charger, charging fault, or TouchConnect error



Off

Off (play/pause to turn on)



Fast blink

Not connected to a network (move within range)

Pulse

Connected to network



Green

Charge complete

## Talkman A730x LEDs

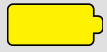

Yellow

Charge in progress



Red

Charge fault



Off

Battery is healthy

Blinking red

Battery has health issue



On

Searching to pair

Fast blink

Attempting to connect

Pulse

Connected



Fast blink

Scanning for headset tag

## SRX3 Quick Reference



Action	Result
Power on	LED solid green High double beep
Power off	LED turns off Low double beep
Change volume	Press Volume Up or Volume Down
Paired/connected	LED blue flash 3 connect tones
Paired/not connected	LED green flash 3 disconnect tones
Mute	Flip microphone up to mute. (SRX3 only)

## Pairing A730x with SRX3

Touch the SRX3 keypad to the raised oval on the A730x side, aligning the NFC icons.



When paired, the device status ring on the A730x blinks green.



## Phonetic Alphabet

Phonetic Alphabet				
Alpha	Golf	Lima	Quebec	Victor
Bravo	Hotel	Mike	Romeo	Whiskey
Charlie	India	November	Sierra	X-ray
Delta	Juliet	Oscar	Tango	Yankee
Echo	Kilo	Papa	Uniform	Zulu
Foxtrot	For a period, say "point"			



# VOICECATALYST M&I FOR PC

VoiceCatalyst® MP M&I for Windows is built on Honeywell VoiceCatalyst 2.3.

## System Requirements

- VoiceConsole 5.0 or above
- Windows 7, 8, or 10

### IMPORTANT

VoiceConsole is supported for Talkman devices running VoiceCheck 1.7 and below.

The following are minimum requirements. A faster processor, larger hard drive, and more memory will improve performance.

- 1 GHz or faster 32-bit (x86) or 64-bit (x64) processor
- 1GB RAM (32-bit processor), 2GB RAM (64-bit processor)

## Language Support

Language	Voice Name	Language Code	Gender	Adjustable Pitch
<b>American English</b>	English (United States) 6	en_US_6	Male/Female	Yes
	German (Germany) 3f	de_DE_3f	Female	Yes
<b>German</b>	German (Germany) 3m	de_DE_3m	Male	Yes
	German (Germany) 6	de_DE_6	Male/Female	Yes
<b>Latin American Spanish</b>	Spanish (Mexico) 2	es_MX_2	Male/Female	Yes
	Spanish (Mexico) 6	es_MX_6	Male/Female	Yes

## Headset Requirements

A Honeywell SRX3 headset using firmware version 3.12 or later is recommended. If you attempt to pair a headset that does not have the suggested firmware version, a message to this effect will be displayed in the VoiceCatalyst MP pairing dialog. You can still use the earlier firmware, but you may experience audio problems. Powering the headset off and powering it on again will fix this issue.

**NOTE**

Upgrading to this version of the headset firmware will not affect its operation with any other devices with which you may have been using it.

**IMPORTANT**

For the best, most reliable audio, you should remain within three meters, or approximately 9.5 feet, of the Bluetooth adapter while using the SRX3 headset.

## Other Tested Configurations

The following is a list of devices and peripherals on which this release has been tested.

- AD-400-1 Bluetooth USB Adapter for VoiceCatalyst MP
- Dell Latitude E5440
- Dell Latitude E6420
- Dell Inspiron 15R
- Dell Precision Tower 5810
- Microsoft Surface Pro
- Intermec SF61 Bluetooth Scanner

## Solution Overview

The Honeywell Voice Maintenance & Inspection Solution incorporates several components and applications that work together to deliver assignments to workers and record their results. The following diagram illustrates how the Honeywell Voice Maintenance & Inspection Solution works.



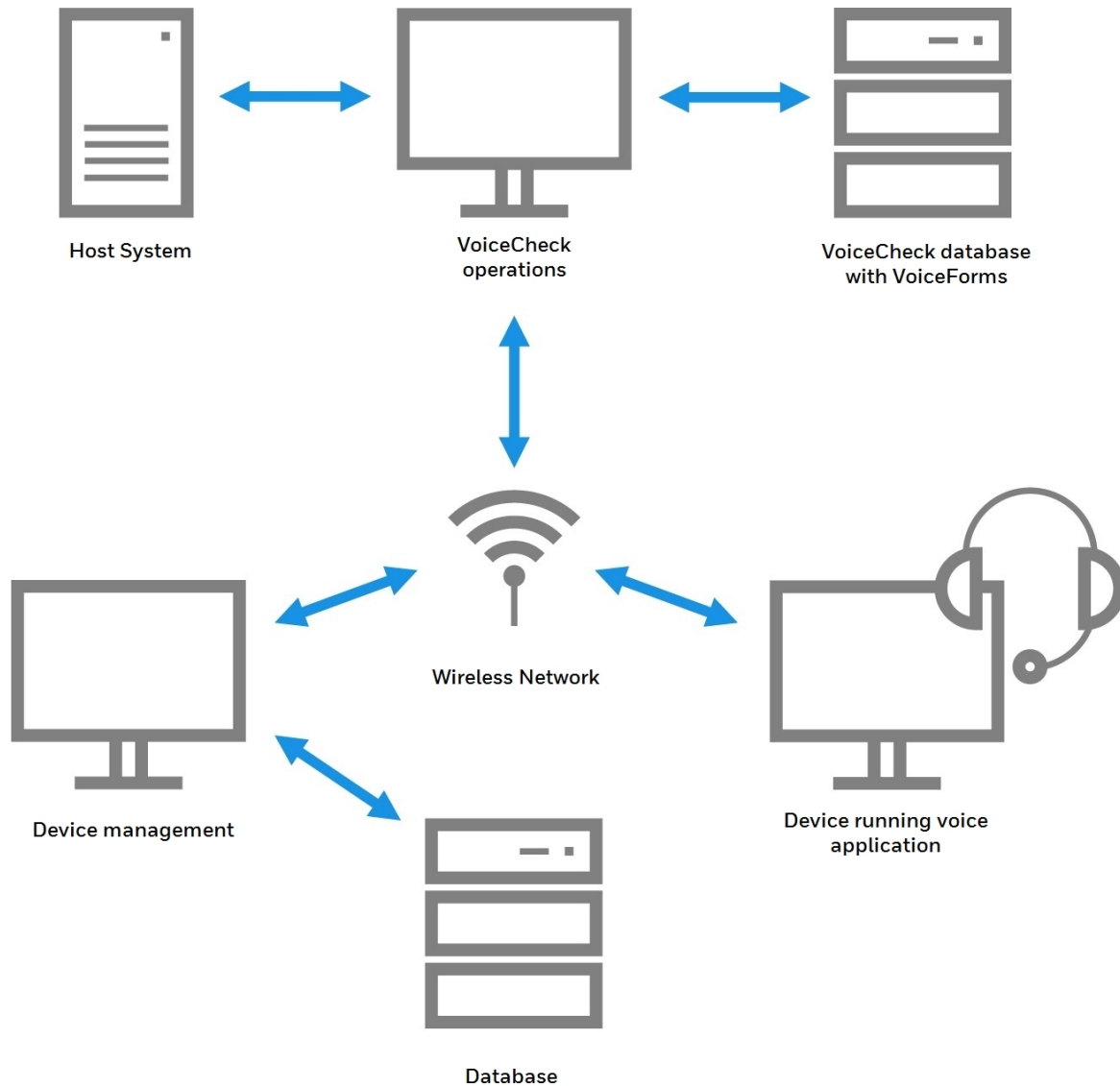

The Honeywell Voice Maintenance & Inspection Solution relies on data transmissions between a customer's host system, Honeywell VoiceCheck, and devices worn by technicians performing inspections.

## Component Functions

- **Host System:** The host system generates assignment data and sends this data via web interface messages to VoiceCheck. After technicians perform the inspections, the host system receives the results from VoiceCheck and updates its data records.
- **Honeywell VoiceCheck:** The VoiceCheck middleware product uses assignment data along with voice prompts defined in a VoiceForm to create voice plans. It transmits the voice plans to Honeywell Talkman devices and receives technicians' response data from the devices. Finally, it exports the inspection results back to the host system.

VoiceCheck provides a web-based graphical user interface for management and tracking of inspection assignments.

- **VoiceConsole:** Administrators use VoiceConsole to configure and manage Talkman devices.
- **Talkman A730x Device:** The Talkman A730x runs VoiceCatalyst MI voice software which translates incoming instructions into audible commands. It prompts technicians to perform each step in an inspection assignment and converts technician responses into output data that is sent back to VoiceCheck.
- **Inspection Voice Application:** The voice application runs on the Talkman A730x and controls all voice interactions between the technician and the assignment.
- **honeywell Wireless Headset:** The SRX3 Headsets pair with a Talkman A730x device. The headset and microphone enable a technician to hear and respond to assignment instructions in a variety of industrial environments.
- **Display Device:** Users can view each inspection step on mobile devices or PCs running supported browsers.

## Data Mapping

Vocollect VoiceCheck provides a method to map data elements from a host system, identify and define specific work tasks, translate those tasks into voice prompts, prompt workers to perform the tasks and record results, and return the results to the host system.

If there is no host system present, VoiceCheck offers GUI pages for defining inspection plans and creating assignments.

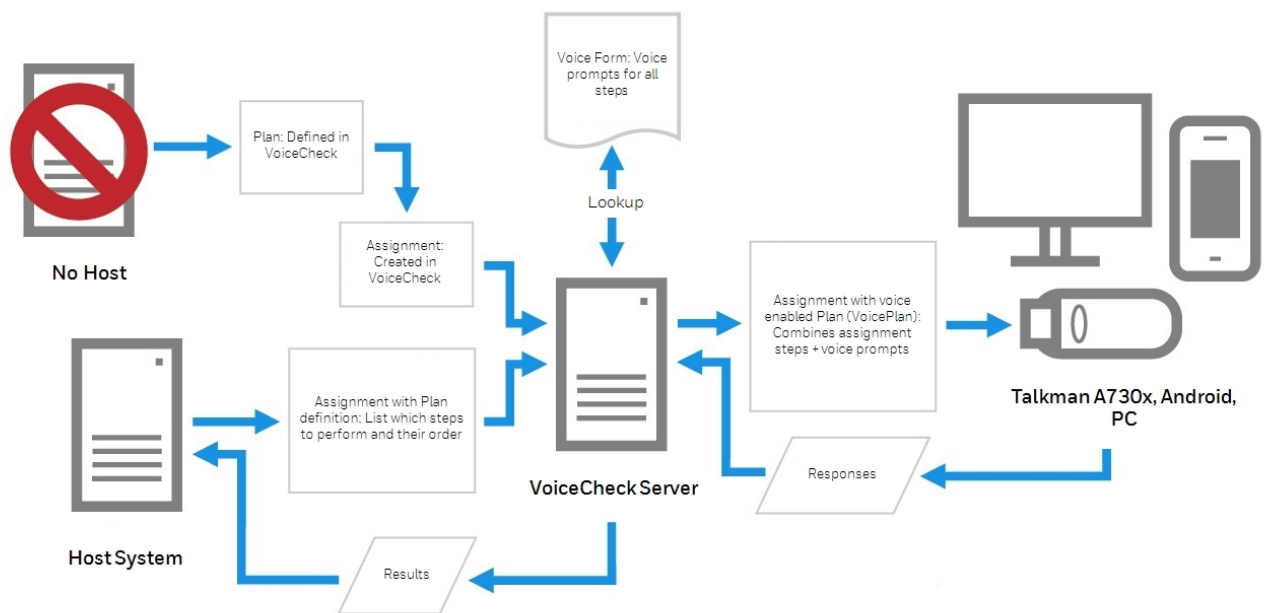

Inspection System Data Integration with or without a Host System

VoiceCheck uses a series of unique identifiers to perform the data tracking, merging, and parsing necessary to complete this process.

## Training on Honeywell Voice and Devices

The Honeywell RapidStart VoiceApplication is a self-guided training system for technicians who are new to voice inspections or who need some refresher instruction. RapidStart uses audio and video cues to teach technicians how to wear and use Honeywell equipment and how to use Honeywell voice solutions. The application also steps them through creating their voice templates.

The RapidStart training requires a Talkman device and any browser-based device with a display, such as a tablet or smart phone.

### NOTE

RapidStart training is only available for Talkman devices.

## Setting Up RapidStart

1. Import the RapidStart task file, **RapidStart<version>.vad**, into VoiceConsole.
2. Create a task package from the RapidStart task.
3. In VoiceConsole, create the new operator and associate the task package for the operator's regular inspection work.
4. Load the training task to a Talkman device.
5. Load the operator to the Talkman device.
6. On the display device, access the main browser page of the Talkman device.

Typically, connect the display device to the same network as the Talkman device and enter the IP address (or the hostname as vv-deviceserialnumber) of the Talkman device in the browser's address bar.

7. Connect a headset to the Talkman device.
8. Give the devices and headset to the technician. The technician begins training by pushing the Play/Pause button.

See VoiceConsole Implementation Guide for more information on RapidStart.

## Training Voice Templates

All new technicians must train their voice templates (all the common words that they will use in the voice-directed workflow) in order to perform an inspection with the Honeywell Voice Maintenance & Inspection Solution. The RapidStart application automatically guides technicians through the template training process.

### HOW TO:

Have each technician put on his or her headset and turn on the paired device.

**Device:** "Please keep quiet for a few seconds."

**Device:** "Please say zero."

**Tech:** "Zero."

**Device:** "One."

**Tech:** "One."

**Device:** "Two."

**Tech:** "Two."

**Device:** "Please say the following words..."

The device prompts each word or phrase at least four times, and the technicians should repeat the prompts naturally. At the end of the training, the device says "Creating voice templates. Please wait." Finally, the device says "Finished creating voice templates," and it goes to sleep.

# VOICECONSOLE AND DEVICE SETUP

Use this section as a guide for installing and configuring [VoiceConsole](#), importing voice software, and setting parameters for Talkman device functionality.

For more detailed instructions, see the [VoiceConsole Implementation Guide](#) and the [Honeywell Voice Software User's Guide](#).

## IMPORTANT

VoiceConsole is supported for Talkman devices running VoiceCheck 1.7 and below.

## Installing VoiceConsole

The release of VoiceConsole included in your Honeywell Voice Maintenance & Inspection Solution includes features developed specifically to support the solution. It offers an option in creating device profiles to use Secure Sockets Layer (SSL) communications between VoiceConsole and Talkman devices. Similarly, while creating a task package, you can select to use SSL-secured communications between VoiceCheck and devices. It also offers a way to ensure proper time synching when devices power up for the first time by including Network Time Protocol settings in device profiles.

## Create a Database

Unless you plan to use the VoiceConsole Embedded Database, you must first install a blank VoiceConsole database, and create a user with create, read, and write permissions to the database.

When you run the VoiceConsole installer, the database schema will be created automatically.

## Run the VoiceConsole Installer

On a Windows platform, you must run the installer as an administrator. Navigate to and run **install.exe** on the DVD.

When installing on Linux, the installer must be run as root. If you are using Intel or AMD architecture, copy the files from the VoiceConsole DVD to your computer and execute the **install.sh** file.

## Configuring Your VoiceConsole Installation

With the installation complete, you can log on to the VoiceConsole application and begin setting up the environment specific to your operations. See VoiceConsole Online Help for detailed instructions.

## Obtain and Import a VoiceConsole License

Honeywell generates and provides you with a license file that lets you run the software according to your purchase agreement.

You must enter a valid license before you can load device profiles, operators, or task packages onto devices. The license must support the total number of devices connecting to VoiceConsole, not the number of devices per site.

### HOW TO:

In the **Administration** section of the VoiceConsole user interface (GUI), navigate to **Licenses** and click the **Import License** action link.

## Create Sites

You can use VoiceConsole to manage your voice solution at multiple sites. Typically, logical sites mirror geographical or physical sites within a company, unless requirements differ among functions at the same location.

### HOW TO:

In the Administration section of the GUI, navigate to **Sites** and click the **Create new site** action link.

If you plan to support multiple sites, you must create the sites in both VoiceConsole and VoiceCheck. Then you must associate a task, task package, device profiles, and operators with each site. You may want to create a task and users that are specific to each site. See "Creating Additional Sites for Multi-Site Implementations" on page 28 for more information. for more instruction.

## Create Roles and Users

**Roles** define what a user is allowed to do in the application. Roles are assigned to users, and users can only access features that are accessible by the user's roles.

### HOW TO:

In the Administration section of the GUI, navigate to **Roles** and click the **Create new role** action link.

For each role, you can grant access to specific features by checking them. Note that if you grant the ability to perform an action on a page (such as, deleting an operator on the View Operator page), you must also grant the ability to view that page.

Each **user** must have a unique username and must be granted at least one role.

Passwords must be changed after the first log in, and must adhere to the following password complexity requirements.

A minimum of 8 characters, including:

- 1 upper-case letter
- 1 lower-case letter
- 1 numeral or special character

New passwords must not match any of the last three user passwords.

Users will be locked out after three invalid login attempts and must wait 15 minutes to try again or contact their system administrator to unlock their account.

#### HOW TO:

In the Administration section of the GUI, navigate to **Users** and click the **Create new user** action link.

## Create Operators

While you create users in VoiceConsole to grant access to the GUI application, you create operators to manage how your technicians are associated with devices, voice templates, and task packages.

In the Honeywell Voice Maintenance & Inspection Solution, every technician requires a user and operator account in VoiceConsole. Not every application user, however, may perform inspections as a Talkman device operator.

#### HOW TO:

In the **Operation Management** tab of the GUI, navigate to **Operators** and click the **Create new operator** action link.

You can associate a task package with each operator.

## Move or Copy Operators among Sites

If your technicians work in more than one site, you must add the associated VoiceConsole operators to those additional sites prior to the technicians arriving.

#### HOW TO:

- In the **Operation Management** tab of the GUI, navigate to **Operators**, select one or more operators in the table, and click the **Move operators > Move/add selected operators to a site** action link.
- Select move to remove the operators from the current site.
- Select add to retain the operators in the current site.

When an operator exists in more than one site, any edits you make to that operator will affect every site where the operator exists. You can, however, delete an operator from additional sites without affecting remaining sites.

**TIP**

In both VoiceConsole and VoiceCheck, you can enable GUI users for any or all sites at any time.

## Add Optional Wireless Security

Your corporate IT policy may require that additional security measures are implemented on your wireless network. Extensible Authentication Protocol (EAP) is a secure means of transferring data on a wireless network from one computer—in this case, a Talkman device—to a network access point. You can configure specific sites to use EAP.

### HOW TO:

In the Administration section of the GUI, navigate to **Sites**, select a site, and click the **Configure EAP for selected site** action link. See VoiceConsole Online Help for guidance in completing the required fields. Repeat for additional sites as needed.

Note that the Honeywell Voice Maintenance & Inspection Solution also offers SSL-encrypted communications between Talkman devices and VoiceConsole. See "Securing Device Communications" on the facing page for more information.

## Configure Optional Authentication

If you want users to log into the application with an application-specific password, ensure that a password is entered for each user account. Optionally, you can choose to allow users to log into VoiceConsole with their directory server (LDAP) passwords.

### HOW TO:

In the Administration section of the GUI, navigate to **System Configuration** and click the **Edit System Configuration** action link.

## Set up Email Notifications

You can configure VoiceConsole to email critical notifications automatically to one or more users.

### HOW TO:

First, assign the users to roles that grant the ability to view notifications. Then add the users' email addresses to their VoiceConsole user accounts. Finally, provide the **Outgoing SMTP Host** information in the **System Configuration** page.

## Importing VoiceCatalyst MI

VoiceCatalyst MI is the Honeywell voice process software that runs on Talkman devices and allows them to interact with tasks (voice applications). They contain the speech components of the Honeywell Voice System.



- Speech recognition engine: enables the device to understand what a technician is saying and converts those responses to data that can be transmitted to the VoiceCheck application.
- Speech synthesis engine: takes data sent from the host system and converts it to speech that technicians can hear and understand.
- Task execution engine: enables the task (voice application) to run on a Talkman device.

Your product DVD contains a .vos file that must be imported into VoiceConsole, then loaded onto your Talkman devices.

#### HOW TO:

1. In the **Device Management** tab of VoiceConsole, navigate to **VoiceClient**.
2. Click the **Import VoiceClient** action link.
3. Select the .vos file from your product DVD.
4. Select the languages that you will support.
5. Select the site(s) at which this voice process software will be available, if you support more than the default site.
6. Accept the license agreement.

## Creating a Device Profile

A device profile contains the voice modules, Honeywell voice process software, and device configuration files to be loaded on a Talkman device so it can operate and communicate properly with the Honeywell Voice Maintenance & Inspection Solution. Voice modules are combinations of language, gender, and country that direct Talkman devices to use different types of speech in delivering instructions.

The VoiceConsole Create Device Profile wizard includes a step to select one or multiple sites in which to create a device profile. This feature allows a single profile setup to be deployed to a large number of sites.

#### HOW TO:

On the Device Management tab of the GUI, navigate to **Device Profiles** and click the **Create new device profile** action link.

Refer to VoiceConsole Online Help for complete instructions for creating a device profile. See "Securing Device Communications" below for more information. for security considerations with device communications.

## Securing Device Communications

VoiceConsole offers an option in creating device profiles to use Secure Sockets Layer (SSL) communications between VoiceConsole and Talkman devices. See "Security Considerations" on page 38 for more information. to understand how device communications fits into a secure Honeywell Voice Maintenance & Inspection Solution.

## Communication Protocols with Devices

VoiceConsole contains a parameter for selecting a secured or non-secured protocol for device communications. If you plan to use SSL-secured communications between VoiceConsole and the devices worn by technicians, you must select the HTTPS option in this field. The default setting is HTTP.

1. In the VoiceConsole **Device Management** tab, navigate to **Device Profiles**.
2. Click the **Create new device profile** action link.
3. Complete the required fields in the device profile wizard.
4. On the **Configure Profile** page of the wizard, open the **Network Configuration** tab.
5. Select the appropriate protocol from the **Device to Console Communications** drop-down menu.
6. Before finishing the device profile, ensure that you have included all required parameters. You cannot edit settings in a device profile once it has been created.

This parameter tells the voice process software running on the devices to use either the HTTP URL or the HTTPS URL for communicating with VoiceConsole.

## Date/Time Considerations for Secured Communication

When a Talkman device powers up, it will attempt to contact an instance of VoiceConsole on the wireless network. If VoiceConsole is configured for SSL-secured communications, it has an HTTPS certificate installed with a specific expiration date. The date/time on the device must fall within the date range of the certificate; if it does not, the connection to VoiceConsole fails.

On an *initial* boot of the device or the first time a device powers up after being unused and uncharged for a long period of time, it does not have a date/time history to make that first connection with VoiceConsole. Instead, the device attempts to obtain the current date/time from the Microsoft time server, [time.windows.com](http://time.windows.com), by default. If your network does not allow access to the default time server, configure an NTP (Network Time Protocol) server on your VoiceConsole server or elsewhere on your wireless network.

The time from the NTP server should be close enough to VoiceConsole time that the certificate will allow the device connection. When the device successfully contacts VoiceConsole, it obtains the remaining time information it needs to function for inspection assignments—the VoiceConsole date/time, if daylight savings time is in effect or not, and the time zone.

## Enabling NTP in a Device Profile

1. In the VoiceConsole **Device Management** tab, navigate to **Device Profiles**.
2. Click the **Create new device profile** action link.
3. Complete the required fields in the device profile wizard.
4. On the **Configure Profile** page of the wizard, open the **Network Configuration** tab.
5. Check the **Enable NTP Client** checkbox.
6. If your network restricts Internet access, replace the default server ([time.windows.com](http://time.windows.com)) with the address of your local NTP service.
7. Before finishing the device profile, ensure that you have included all required parameters. You cannot edit settings in a device profile once it has been created.

### TIP

If you power up a Talkman device that cannot match the certificate date and connect to VoiceConsole, you must perform a device profile load via serial cable. See "Configuring Talkman Devices" on page 96 for more information.

## Persistent Pairing of Headset and Device

When removed from the charger, the Talkman A730x device searches for the previously paired SRX3 headset. If your technicians do not have specific A730x devices dedicated for their own use, you can facilitate the pairing process by disabling persistent pairing.

This setting is changed in the device profile in VoiceConsole. Because you cannot edit the settings of an existing device profile, you will have to create a new profile based on the existing profile.

1. In VoiceConsole, click the **Device Management** tab.
2. In the navigation pane, click **Device Profiles**.
3. Click the **Create new device profile** action link.
4. Enter the profile name.
5. Select **Full Profile** for the **Profile Type**.
6. Select the appropriate voice software from the **Vocollect VoiceClient** drop-down menu.
7. Select a voice to associate with the profile from the **Voices** drop-down list, then click **Next**.
8. On page 2 of the **Create Device Profile** process, select **Copy from existing profile**, and select the profile from the drop-down menu. Click **Next**.
9. On the **Advanced Settings** tab, enter the following parameter and value so that headset pairing will be cleared every time an A730x device is placed in a charger.  
`"SrxClearPairingInCharger"= "1"`
10. Click **Finish**.
11. On the **Device Profiles** page, select the new profile and click the **Load selected profile to devices** action link.
12. Select the appropriate devices, and click **Load profile**. See VoiceConsole Online Help for additional instructions.

## Importing a Task and Creating a Task Package

Honeywell devices work in conjunction with voice process software (voice applications). The software directs the devices to give specific instructions to technicians and specifies what the devices will do when technicians respond to the prompts.

The Honeywell Voice Maintenance & Inspection Solution task is delivered with your product as a .vad file. This file must be imported into VoiceConsole in order to create a task package that can be sent to the Talkman devices.

### HOW TO:

Navigate to **Tasks** and click the **Import Task** action link.

A task package bundles your voice process software with specific settings and is used to transmit the software to the Talkman devices.

The VoiceConsole Create Task Package wizard includes a step to select one or multiple sites in which to create a task package. This feature allows a single task package setup to be deployed to a large number of sites.

#### HOW TO:

Navigate to **Task Packages** and click the **Create new task package** action link. In completing the fields, include any additional settings for your implementation of the Honeywell Voice Maintenance & Inspection Solution. See the following section for guidance.

## Task Package Settings in VoiceConsole

### Batch Assignments

Technicians generally work one assignment at a time. The batch assignment feature, when enabled, allows technicians to work on multiple assignments, switching among them as needed. By enabling this feature, the "select assignment" and "current assignment" commands become available in the workflow.

1. In VoiceConsole, click **Task Packages** in the navigation pane.
2. On the **Task Packages** page, select the task package containing your voice application, and click the **Edit selected task package** action link.
3. In the **Task Settings** section, check the **AllowMultipleAssignments** checkbox to enable the feature.
4. Save changes and reload the task package. See VoiceConsole Online Help for additional instructions.

### VoiceNote Recording Time

The default duration for a technician to record a VoiceNote is five seconds. This setting can be changed in VoiceConsole up to a maximum duration of 30 seconds.

1. In VoiceConsole, click **Task Packages** in the navigation pane.
2. On the **Task Packages** page, select the task package containing your voice application, and click the **Edit selected task package** action link.
3. In the **Task Settings** section, edit the **maxRecordingSeconds** field.
4. Save changes and reload the task package. See VoiceConsole Online Help for additional instructions.

### Display Device and Photo Steps

In order to see inspection steps on a display device or PC browser, you must enable screen support for the voice application web service. This setting must also be enabled for steps requiring photos to be taken as the technician must manually activate photo capture from a button on the screen.

1. In VoiceConsole, click **Task Packages** in the navigation pane.
2. On the **Task Packages** page, select the task package containing your voice application, and click the **Edit selected task package** action link.
3. In the **Task Settings** section, check the **useHTTPserver** checkbox.
4. Save changes and reload the task package. See VoiceConsole Online Help for additional instructions.

#### NOTE

This feature only supports unsecured HTTP transmissions.

## Spoken Numbers vs. Spoken Digits

The Talkman device speaks two-digit numbers as natural numbers and all longer numbers as strings of digits by default. For example, the device speaks "twenty-six" as a natural number for 26, and it speaks "two six zero" as a digit string for 260. This setting can be changed in VoiceConsole to instruct the device to speak digit strings for all numbers or to speak natural numbers for additional lengths of numeric values.

To set this behavior for all technicians:

1. In VoiceConsole, click **Task Packages** in the navigation pane.
2. On the **Task Packages** page, select the task package containing your voice application, and click the **Edit selected task package** action link.
3. On the **Device Settings** tab in the **Advanced Settings** field, enter the following parameter, replacing X with the appropriate value:  
**"MaxSpeakAsNumber=X"**
  - "0" to turn off all natural number prompts; all numbers are spoken as separate digits
  - "99" for speaking two-digit natural numbers; all numbers with three digits or more are spoken as digits
  - "999" for speaking up to three-digit natural numbers; all numbers with four digits or more are spoken as digits
4. Save changes and reload the task package. See VoiceConsole Online Help for additional instructions.

To set this behavior for each technician to allow for individual preferences:

1. In VoiceConsole, click **Operators** in the navigation pane.
2. In the Operators table, select the operator record for a specific technician.
3. Click the **Manage operators > Edit selected operator** action link.
4. In the **New Advanced Settings** field, enter the parameter as described above.
5. Save changes.

## Fraction Words in Template Training

If your inspection assignments include any fractional value entry, you must enable the voice application to accept the words used in fractional measurements and have your technicians train those words in their voice templates. These words include half, fourths, eighths, sixteenths, and thirty-seconds.

The Honeywell Voice Maintenance & Inspection Solution comes with the appropriate words configured but disabled. With these words disabled, your technicians will not have to train unnecessary vocabulary.

To enable fraction words:

1. In VoiceConsole, click **Task Packages** in the navigation pane.
2. On the **Task Packages** page, select the task package containing your voice application, and click the **Edit selected task package** action link.
3. On the **Device Settings** tab in the **Advanced Settings** field, either delete the relevant DisableVocabWord entries or set their values to zero (0):

"DisableVocabWord\_<word>=X"

where X=1 for disabled and X=0 for enabled

4. Save changes and reload the task package. See VoiceConsole Online Help for additional instructions.

## Speech Recognizer Sensitivity by Word

The Honeywell speech recognizer can be adjusted to reduce unintended insertions when technicians speak infrequently used words, or to increase the likelihood of acceptance for some words.

You can set the parameter **BlueStreak\_Decode\_Sensitivity\_<word>=<threshold>** to adjust the sensitivity level to achieve the appropriate balance in recognizer sensitivity for specific words based on your application workflow.

- The default sensitivity threshold is 0.
- The setting can be a positive or negative number.
- Increasing the sensitivity reduces insertions by requiring the recognizer to be more confident of what the user spoke. This makes the recognizer more likely to accept the correct word and ignore other utterances.
- Decreasing the sensitivity reduces the need for technicians to repeat responses by enabling the recognizer to accept a word with less confidence. Decreasing sensitivity, however, may increase insertions and is typically not recommended.

Honeywell recommends setting the threshold between 1 and 2 for infrequently used vocabulary words for the best performance balance. This setting eliminates most insertions of the word with only an infrequent rejection of words that should have otherwise been accepted. A setting higher than 3 will likely require significant repeating and is not recommended.

For example, to reduce insertions of the infrequently used vocabulary word "sign off," set the parameter to 2 to increase the sensitivity.

```
BlueStreak_Decode_Sensitivity_sign_off=2
```

When a technician speaks "sign off," the recognizer will accept the word and move on with the task only if it has a higher level of confidence that the technician actually spoke "sign off."

To modify the sensitivity parameter:

1. In VoiceConsole, click **Task Packages** in the navigation pane.
2. On the **Task Packages** page, select the task package containing your voice application, and click the **Edit selected task package** action link.
3. On the **Device Settings** tab in the **Advanced Settings** field, enter the following parameter, replacing <word> and X with the appropriate values:  
**"BlueStreak\_Decode\_Sensitivity\_<word>=X"**
4. Save changes and reload the task package. See VoiceConsole Online Help for additional instructions.

Contact your Honeywell Support representative if additional assistance is needed with determining proper settings.

#### TIP

To further reduce insertions and repeating of specific words, the number of discrete repetitions during voice template training can be increased to improve performance. The more times a word is trained, the more likely the recognizer will accept it when first spoken or ignore it due to other noises.

#### NOTE

To increase the number of iterations of a word during enrollment training, add new word combinations to the Embedded Training within the task package in VoiceConsole and reload the task. In addition, for particularly problematic words, the operator may always retrain a word via the menu options to force a retrain with 10 iterations.

## VoiceCheck Server Address

The VoiceCheck server IP address and URI are set in the task package in VoiceConsole. If either of these locators changes for the server, the task package settings must be updated.

1. In VoiceConsole, click **Task Packages** in the navigation pane.
2. On the **Task Packages** page, select the task package containing your voice application, and click the **Edit selected task package** action link.
3. In the **Task Settings** section, enter the appropriate information in the **serverHost** and **serverURI** fields.
4. Save changes and reload the task package. See VoiceConsole Online Help for additional instructions.

## Site

A site is the location where a technician, who is wearing a Talkman device and following a voice-directed workflow, is working.

Note that the site name is referenced in three different functions of the Voice Inspection Solution, and all three must match:

- The Site Name field in the **Administration** section of the user interface,
- The Site setting in the task package accessed via VoiceConsole,
- The siteName field in all web service messages used for import and export.

## SSL Security

You can configure the Inspection VoiceApplication to use SSL security to secure data communications between VoiceCheck and the voice process software running on the Talkman devices. If the VoiceCheck server is configured to use SSL, this setting must be set to on (checked).

### NOTE

The VoiceCheck server must use an SSL certificate obtained from a trusted certificate authority. See "HTTPS Certificate Installation" on page 46 for more information..

This setting, when turned on, applies to all VoiceCheck sites.

1. During the VoiceCheck installation, set the Tomcat HTTPS port, check the "Enable HTTPS Support" checkbox, and complete the keystore fields.
2. In VoiceConsole, click **Task Packages** in the navigation pane.
3. On the **Task Packages** page, select the task package containing your voice application, and click the **Edit selected task package** action link.
4. In the **Task Settings** section, check the **useSSL** checkbox.
5. Save changes and reload the task package. See VoiceConsole Online Help for additional instructions.

## Save State

The task package contains a checkbox to save the state of the application running on the Talkman device during a power off. This setting should always be checked for production environments so that a technician can return to the same place in the workflow when he or she turns on the device again.

## Configuring Talkman Devices

### Installing USB Driver

If your VoiceConsole implementation is on a Windows operating system, you may need to install the USB driver located on the VoiceConsole DVD in order to use the maintenance port on Talkman A700x devices. The necessary driver is already installed on Linux systems.

#### HOW TO:

Connect an A700x device to the USB port on the Windows machine. The USB driver (CDC-ACM driver) should install automatically. If it does not install, perform these steps for a manual installation.

1. Open **Windows Device Manager**.
2. Find and right click **Talkman USB Serial** in the list of devices.
3. Select **Update Driver Software** and follow the directions pointing the search to the VoiceConsole software DVD to locate the CDC-ACM driver.



## Loading a Device Profile to the First Device

With a device profile set up, you must load it to at least one Talkman A700x device. You may have to load the profile to the first device using a serial cable and Java applet.

### HOW TO:

On the Device Management tab of the GUI, navigate to **Device Profiles**, select the device profile you want to load, and click the **Load selected profile with cable** action link.

- If you get a message to download files to your computer, follow the instructions in the message, restart your browser, then begin the profile load again.
- For most implementations, keep the default settings in the **Prepare the Device** section of the profile load process.
- When the load process begins, the ring LED on the Talkman A700x device rotates yellow. When complete, the device reboots.

## Loading the Remaining Devices

You can load the device profile to the rest of your devices in two ways: by Honeywell TouchConfig or through VoiceConsole.



### Using TouchConfig

When you have a single A700x device configured, you can use the TouchConfig feature to quickly transmit that configuration to your remaining devices.

### HOW TO:

On the Device Management tab of the GUI, navigate to **Devices**, select the single device you want to load, and click the **Common Device Actions > Load profile to selected devices** action link.

Next, bring additional devices online with TouchConfig:

1. Start with all devices turned off.
2. On the configured device, press and hold the Plus (+) button then press the Play/Pause button to put the device into sender mode. The LED ring's small segment will be solid yellow, and the NFC indicator will blink yellow.
3. On the unconfigured devices, press and hold the Minus (-) button then press the Play/Pause button to put the devices into receiver mode. The ring's large segment will be solid yellow, and the NFC indicator will blink yellow.
4. Turn each unconfigured device so the side with the  symbol faces up.
5. Hold the configured device with the  symbol facing down. Align the raised oval on the device with the raised oval on an unconfigured device. Ensure that the ovals are fully aligned, then hold the two devices steadily against each other.
6. Watch the LED ring on the receiving device. It blinks green then signals a reboot by rotating yellow then red for a successful configuration transfer. On failure, the ring blinks red then returns to receiver mode.
7. Repeat the TouchConfig for remaining unconfigured devices.

## Using Chargers and VoiceConsole

If you set the device profile as the default profile for the site, you can load the configuration on devices seated in a charger with a VoiceConsole GUI action.

A device in the charger is in maintenance mode, which is required to complete the profile load.

### HOW TO:

On the Device Management tab of the GUI, navigate to **Devices**, select the devices you want to load, and click the **Common Device Actions > Load profile to selected devices** action link.

## Loading a Task Package

A task package contains the process software that speaks instructions to technicians performing inspections, along with some settings specific to that software. The task package must be loaded onto the Talkman devices, either directly or by association to operators.

### Loading a Task Package onto Devices

You can send a task package to all of the devices in a site.

#### HOW TO:

In the **Device Management** tab, navigate to **Devices** and click the **Common Device Actions > Load task package to all devices** action link.

### Associating a Task Package with Operators

A task package can be associated to operators instead of being loaded to devices. With this method, the associated task package is loaded automatically onto a device when the operator is loaded onto that device—whether via VoiceConsole, from the device menu, or by connecting the operator's headset to the device. The operator can begin working without having to load a task manually using the device menu.

#### HOW TO:

In the **Operator Management** tab, navigate to **Operators**, select one or more operators, and click the **Common operator actions > Associate task package with selected operators** action link.

# SYSTEM MAINTENANCE AND PROTECTION

This section contains guidelines for protecting your Honeywell Voice Maintenance & Inspection Solution implementation and VoiceCheck data.

Honeywell strongly recommends that your IT staff develops and implements a disaster recovery plan specific to your company's needs.

**WARNING**

If your VoiceCheck database service goes down or requires a restart, you *must* also stop the VoiceCheck application service. Start the application service again only after the database is fully up and running.

**WARNING**

Please note that restarting or otherwise interrupting the VoiceCheck server during inspection operations can lead to excessively long restart times and may necessitate restarting the devices connected to the server. This may lead to data loss and loss of all assignment data currently on the device. Honeywell recommends that software updates and other maintenance be scheduled when the VoiceCheck system is not being actively used for inspections.

## Changes to Master Data and VoiceForms

When changes are made to a host system's master data, corresponding edits will need to be made to the VoiceForms for any affected sites. For example, the step IDs found in the VoiceForms must be kept in sync with the assignment data sent to VoiceCheck from the host system. See the Honeywell Voice Inspection Solution Online Help for more information on VoiceForms.

**TIP**

Users on VoiceCheck 1.7 or above should use VoiceForm versioning. See Create and Edit VoiceForms in Honeywell Voice Inspection Solution Online Help and [VoiceForm](#) and [VoicePlan](#) Web Services for more information on how to create VoiceForm versions.

The following chart shows how to address some common changes.

## Data change

## You need to . . .

Changing prompt phrases and help messages

- Edit the VoiceForm steps at any time to modify these phrases.
- Note that changes may confuse a technician who reviews previous responses with new prompt wording.

Editing existing response option words for multiple list selection prompts

- Edit the List Item Group to modify these items as long as the Items Key (Group Code) does not change.
- Note that you cannot modify an existing group if it is referenced by VoiceForm step.

Adding a new response option to an existing list

- Edit the List Item Group to add another item code and text value.
- Note that you cannot modify an existing group if it is referenced by VoiceForm step.
- Ensure that the host system is updated to expect the new value.

Adding a new inspection check

- Add the step information in the **createAssignment** web service message and import to VoiceCheck.
- Add the step with the correct step ID to the VoiceForm using the VoiceForm Editor.
- If you define the new step with a multiple list selection prompt, edit the List Item Group to add the relevant response options with a new item code.
- Note that you cannot modify an existing group if it is referenced by VoiceForm step.

Adding completely new materials to be inspected by your technicians

- Create any new steps needed with the correct step IDs to the VoiceForm using the VoiceForm Editor.
- Edit the List Item Group to add new response options with new item codes if you define any new steps with multiple list selection prompts.
- Note that you cannot modify an existing group if it is referenced by VoiceForm step.
- Use the **createAssignment** web service message to import all required data for the new inspection plan to VoiceCheck.

Correcting misspoken prompts

- See the Honeywell Voice Inspection Solution Online Help for more information.

Changing a step ID

- Create a new step instead and save your VoiceForm
- Leave the original step in place until it is no longer referenced by any assignments in the system.

## Data change

## You need to . . .

Changing prompt types, conditions, or display IDs within a step

- Update web service messages to include the new step where needed.
- Wait until all assignments are completed, exported, and purged from VoiceCheck. This method ensures that the step is no longer referenced by any assignments in the system.
- Edit the VoiceForm to make the necessary modifications.
- If the step you want to modify is referenced by another step in a condition statement or display setting, the prompt type cannot be changed.

Deleting a step

- Wait until all assignments are completed, exported, and purged from VoiceCheck. This method ensures that the step is no longer referenced by any assignments in the system.
- Select the step in the VoiceForm Editor, and click the **Delete selected steps** action link.
- You cannot delete a step if it is referenced by another step in a condition statement or display setting.
- Save your VoiceForm files and import them to the proper location on the VoiceCheck server.

### CAUTION

Be extremely careful when changing or deleting information in a VoiceForm. Missing data can cause the Honeywell Voice Maintenance & Inspection Solution components to be out of sync and may result in the corruption of current and future assignments.

## Changing Purge Intervals

Honeywell Voice Maintenance & Inspection Solution checks for data that must be purged from the database according to schedules set up for these processes in the **View Schedules** page. See "Setting Up Job Schedules" on page 37 for more information. for more information about how to change how often these processes are run.

Different types of data are purged according to different time intervals. You can modify these intervals in the **System Configuration** settings. Refer to the VoiceCheck Online Help for more detail about editing the system configuration.

## Considerations for Purge Intervals

Your data usage and retention policies are specific to your needs, so when optimizing your VoiceCheck database purge intervals, consider the following factors.

- Data storage and retention in a system of record. With a solid policy for host system data, you can treat VoiceCheck data as temporary for active assignments and near-term troubleshooting only.
- Retention of VoiceNotes and memos results. Your VoiceNotes and transcription performance may require continued analysis by Honeywell. Purged VoiceNotes and memos cannot be recovered.
- Amount of available hard drive and database space.
- Average number of assignments per day or week and size of assignment data.
- Average number of VoiceNotes and memos recorded per assignment.
- Number of users.

For a usage scenario based on 500 technicians completing three 300-step assignments per user per day and five recorded VoiceNotes or memos per assignment, a twice weekly purge should be more than adequate. For a higher volume of VoiceNotes and memos per day, consider purging assignments more frequently since audio files take longer to purge and VoiceNotes and memos are not purged until the associated assignments are purged. These scenarios assume that the server and database meet the minimum system requirements.

You should monitor your system for a few weeks to analyze data size and purge job run time and determine the optimal purge schedule.

## Database Maintenance

Honeywell recommends that you run a full backup of your VoiceCheck database daily during off hours. Along with the backup job, you should backup the transaction log and rebuild all database indexes.

If you support more than 500 technicians, you may need to perform special maintenance on the **core\_assignment** and **core\_assignment\_check** database tables. Honeywell recommends reorganizing the index based on the volume of assignments and steps and the rate of transactions performed on these tables.

SQL Server provides tools to configure these maintenance jobs and has an index report for monitoring the health of database indexes. This report can help you determine the frequency at which the indexes should be reorganized or rebuilt.

Honeywell recommends that a database administrator monitor the system during the first week of heavy use to determine an optimal indexing strategy.

### WARNING

If your VoiceCheck database service goes down or requires a restart, you **must** also stop the VoiceCheck application service. Start the application service again only after the database is fully up and running.

## System Configuration

This page displays system configurations that apply to the entire installation of VoiceCheck across sites.

From the **System Configuration Actions** list in the navigation bar, you can edit the system configuration.

## Editing System Configuration Properties

1. Under **Navigation**, click **System Configuration**.
  2. Under **System Configuration Actions**, select **Edit System Configuration**.  
The **Edit Configuration** page opens.
  3. Modify existing information in the fields, if necessary, and enter the new information.
  4. Click **Save changes**.
- 
1. Navigate to **Administration > System Configuration** page.
  2. Click the **Edit System Configuration** action link.
  3. Modify the editable fields as needed, and click **Save changes**.

## Field Definitions

### SMTP Configuration

- **Outgoing SMTP Host:** SMTP host name. This is required to enable the application to email notifications to specified users.
- **Requires Authentication:** Check if the SMTP host requires authentication. If checked, you will be prompted to enter the following:
  - **SMTP User Name:** Enter the user name to log into the SMTP host.
  - **SMTP Password:** Enter the password associated to the SMTP user name.
  - **Verify Password:** Re-enter the password associated to the SMTP user name.

### User Authentication

If you want users to log into the application with an application-specific password, do not check this option. If this option is unchecked, you must ensure that a password is entered for each user's record.

If you check this option, users can log into the application using their directory server password. When checked the following fields are displayed to facilitate this feature:

- **Host:** Enter the hostname or IP address of the directory server.
- **Port:** Enter the port on which the directory server is listening for connections.
- **Search User Distinguished Name/Password:** Enter the username and password of a trusted user who has search permission on the directory server. This is not required because many LDAP servers support anonymous directory server binding.
- **Search Base:** Enter the location within the directory server to begin a user search.
- **Searchable Attribute:** Enter the attribute on the directory server that maps to the username of a user entered in the application. This may be uid, sn, or another attribute, depending on the directory server setup.

## Post Assignment Results Web Service Settings

The connection parameters used to send results from VoiceCheck to the host system.

- **Service Endpoint:** Enter the URL for the web service endpoint for services provided by the host system. This is a required field.
- **Client Type:** Choose REST or SOAP web services for all data transmission between VoiceCheck to the host system.
- **Export to Interface:** Check this option if you want results data exported to flat, interface tables that can be queried for reporting purposes.
- **Requires Authentication:** Check this option if access to the service endpoint requires a username and password, then supply the credentials in the appropriate fields.
  - **User:** Enter the user name.
  - **Password:** Enter the password associated to the user name.
  - **Confirm Password:** Re-enter the password associated to the user name.

## Transcription Server Settings

The transcription service endpoints for transcribing VoiceNotes and memos.

Enter one or more URLs for the REST web service endpoints. Type each URL on a separate line. The connection can either be secured by a certificate (HTTPS) installed on the transcription engine server, or not secured (HTTP).

If this field is left blank, VoiceCheck will use the integrated transcription service.

## Android Settings

- **OpAcuity URL:** URL to proxy server for Operational Acuity data collection.
- **Use Operational Acuity:** Mode that enables Operational Acuity data collection.
- **Allow Multiple Assignments:** Mode that enables work on multiple assignments. Default is off.

## Export Settings

- **Allow Auto Export:** Check the box to post results to the Host system as soon as an assignment is completed. Uncheck the box to require the user to submit assignments manually.
  - Click **Manage exports** from the VoiceCheck tab to stop or start exporting. Exporting starts upon server reboot.
- **Export mode:** Choose PUSH or PULL from the drop-down box. PUSH assignment exports send data to the host system when assignment data is ready. PULL assignment exports allow the host system to call the server to get the data. There are three REST web services available to PULL data from assignment exports, See "Data Transmission" on page 113 for more information..



## Password Expiration Settings

- **Maximum Password Age (Days):** The maximum number of days before a password expires.
- **Notification (Days):** The number of days before password expiration to provide notification that password must be updated.

Entering 0 for either parameter value disables that parameter.

## Purging Data

Specify the amount of time that specific data remains in the system before the scheduled job will purge it. This group of rules affects the frequency of purging data for assignments, VoiceNotes, memos, photos, notifications, reporting data, and scheduler history.

Purging data that has or has not been exported to the host system depends on the associated assignments. Photos, VoiceNotes, and memos will not be purged if their assignments are still in the VoiceCheck system. Additionally, if the photos purge is set to less than one day, the purge will default to one day to allow time for photos to be associated with assignments that are in progress.

### NOTE

System performance may degrade if you set this parameter to allow data to age more than 90 days before it is purged.

The VoiceCheck system currently only supports transactional data—data that is currently viewed in the GUI—and flat data tables for reporting. Purging this data removes the data from the system completely. This data can no longer be viewed in the application.

## Purging/Archiving Data

The schedule that specifies when data is purged or archived is specified on the Schedules page.

On the System Configuration page, you can specify the amount of time that specific data remains in the system before the scheduled Purge/Archive process will purge or archive it. This group of rules contains the specific rules that affect the frequency of archiving and purging data for Inactive Action Items, Device Messages, Closed Device Logs.

For transactional data, data that is currently viewed in the application tables, that has a Status of Enabled or Disabled, you can specify when the transactional data should be purged. Purging the transactional data removes them from the system completely. This data can no longer be viewed in the application.

## Troubleshooting

This section provides some advice about how to solve common problems that can be encountered when using and maintaining the Honeywell Voice Maintenance & Inspection Solution.

See See "Notifications and Logs" on page 109 for more information. for information on device logging.

## Technician forgets to sign off

**Problem:** An assignment cannot be worked because it is associated with an operator who is not on the current shift.

**Likely Cause:** The technician working that assignment forgot to sign off.

**Resolution:** You can sign off the technician via the **Operator** page in the VoiceCheck user interface. Select the technician's operator record on this page and click the **Sign off selected operators** action link.

## Technician prompted to retrain a word after template training

**Problem:** The technician completes the voice template training, and the device prompts the technician to retrain a word when he or she attempts to run the voice application to begin working.

**Likely Cause:** The speech recognizer had difficulty deciphering a word during the initial training.

**Resolution:** Try retraining the word via the device menu. If needed, add another instance of this word, in a different word combination, to the embedded training list in the task package.

1. In VoiceConsole, click **Task Packages** in the navigation pane.
2. On the **Task Packages** page, select the task package containing your voice application, and click the **Edit selected task package** action link.
3. In the **Embedded Training** tab, find the entry(ies) that contain the problem word.
4. Add a new pair or trio of words at the bottom of the list, including the problem word and separating each word with spaces and pipe characters ( | ).

Ensure that the new entry contains different word sounds than the existing entries with the problem word. This example adds an entry for the word "quarter."

**Existing:** 2 | and | 1 | quarter

**New:** 3 | quarter | ready

5. Click the **Add row**  button to save the new entry.
6. Click **Save Changes** and reload the task package. See VoiceConsole Online Help for additional instructions.

## Technician receives "cannot load task" message

**Problem:** The device speaks the message, "cannot load task. Processing data."

**Likely Cause:** The technician has critical outstanding data that must be sent to the server but the data is unable to be sent because the network is down or the technician is out of range of the WiFi network.

**Resolution:** If the server is running fine, the technician should move back into range. If the problem continues, try turning the device off and on, reloading the task, rebooting the device, or reloading VoiceCatalyst MI.

## The device keeps beeping

**Problem:** There is a delay in data transfer between the Talkman device and VoiceCheck.

**Likely Cause:** Network congestion or other problems are causing slowness or interruption in data communication.

**Resolution:** If there are no reported network problems at your location, the technician should wait a few minutes for the data transfer to complete. If the beeping continues, check device logs in VoiceConsole to diagnose the problem. See VoiceConsole Online Help for instruction on turning on device logging.

## The device cannot get data after a full charge

**Problem:** The Talkman device was left without a battery, or left uncharged to the point where the device battery was completely drained, and its clock battery ran down to empty. (The clock battery typically takes a few days to run down on a device with no battery charge.) After the device was fully charged again, the device cannot connect to VoiceConsole. A network time server is unavailable or not in use.

**Likely Cause:** A WiFi network problem is preventing data communication, or the SSL authentication has failed between the device and VoiceConsole. When a device's clock battery completely loses its charge, the device clock resets to January 2000 after re-charge and power on. When the device attempts to connect to VoiceConsole, the SSL validation fails because the device date is outside of the SSL certificate's date range.

**Resolution:** Ensure that your network time server is functioning and that the NTP option is checked and pointing to the correct server in the device profile. Add a date parameter to the device profile. Create a new device profile in VoiceConsole based on your existing device profile, and add the following parameter with a current date.

```
[HKEY_LOCAL_MACHINE\Software\Vocollect]
"DefaultDate" = "MM/DD/YYYY"
```

Your system administrator should be able to determine the valid date range for the certificate that is in use.

## Host system rejects a data submission

**Problem:** The assignment results submitted from VoiceCheck to the host system returns an error message on the **Review and Submit** page of the user interface.

**Likely Cause:** The error message indicates the cause. Reasons for error include, but are not limited to:

- Another host system user has the data locked,
- The user trying to submit results does not have the appropriate permissions in the host system,
- One or more steps were completed by a user without the necessary permissions in the host system,
- One or more steps were already completed in a host system that only allows entering results one time for each step.

**Resolution:** Resolve access problems or data conflicts and have the technician attempt to submit results again. Otherwise, manual entry in the host system may be required.

## Photo file upload generates a system error

**Problem:** Technicians consistently experience problems when uploading images, and the system generates errors. The GUI displays "Error sending image, try again," and the system log reports Java heap space errors recorded as "OutOfMemoryError: Java heap space."

**Likely Cause:** The image file is larger than 10 MB.

**Resolution:** Use a photo capture device or a device setting that produces smaller photo files. Alternatively, increase the server's Java memory settings by performing the following steps.

1. Run the VocollectWebApplicationsVoiceCheckw.exe file in the bin folder of the Tomcat install under the Vocollect directory.
2. Click on the Java tab.
3. Add to the base Maximum Memory Pool setting.
  - A base 1024 MB recommended for small load implementations
  - A base 2048 MB recommended for up to 2500 workers
  - Add an extra 1024 MB for the internal transcription engine
  - Add extra memory for consistent large photo file uploads
4. Change the Initial Memory Pool setting as needed.
  - 512 MB recommended for small load implementations
  - 1024 MB recommended for up to 2500 workers
5. Set Thread stack size (1024 KB recommended).
6. Click OK to save the settings.
7. Restart the Tomcat service.

## VoiceNote transcription requests fail

**Problem:** Automated transcription is not working for VoiceNotes; there is no transcribed text appearing with the VoiceNote recordings on the **Review & Submit Assignment** page.

**Likely Cause:** The speech recognition engine may crash when the first client request after a restart contains an audio file without any human speech in it.

**Resolution:** Restart the transcription server.

The Vocollect Transcription Server is deployed as a standalone web service. The VoiceCheck server connects to this web service as a client and sends audio files for automatic speech-to-text conversion.

1. Log in to the host (VM or otherwise) that is running the Vocollect Transcription Server. (This procedure assumes a Windows operating system.)

2. Click **Start > Run** and type "services." Click Enter to open the services applet.
3. Locate and select the Vocollect Transcription Service.
4. Click on the **Restart** link. The service should restart quickly.

Restarting the transcription server should only result in a few seconds of downtime. During this time, automated transcription of VoiceNotes is not possible; however the VoiceCheck server should automatically resend all rejected requests. Only a slight delay in transcriptions should result from the restart procedure.

## Notifications and Logs

Both logs and notifications inform users of various actions that are taking place in the system and errors that may have occurred. VoiceCheck and VoiceConsole maintain system logs and provide notifications in the user interface.

- Notifications are messages that the application sends to alert users to various events. These messages can be viewed on the **Notifications** page, and critical notifications also appear in a colored banner at the top of the interface when they occur. The system can be configured to email critical notifications to specific users.
- You can take responsibility for the resolution of a notification by acknowledging that notification. Other users can see who acknowledged the notification and when it was acknowledged.
- Logs track user activities in the application and are useful for analyzing unexpected situations or issues. You can view a list of logs that have been generated by the application on the **Logs** page, and you can save a log as a zip (compressed) file.

### Server Logs

Two types of logs are generated by Apache Tomcat and displayed in the **Logs** page. In most cases, you will not need to reference these logs.

The Honeywell-specific logs are preceded by "Vocollect" or "VoiceCheck" or "VoiceConsole." These are the logs typically referenced for troubleshooting. These logs are created using log4j. You can learn more about log4j at the following sites:

- <http://logging.apache.org/log4j/2.x/>
- <http://www.developer.com/open/article.php/3097221>

See the Honeywell VoiceConsole Implementation Guide for details on VoiceConsole log files.

#### VoiceCheck log

This log is named according to the following naming convention:

VoiceCheck.log.n

where n is the number of the log. The most recent log has no value for n, the next-most recent log has a value of 1 for n, and so on.

The VoiceCheck log contains all information logged according to the logging level set in the log4j configuration file. This level is set to INFO by default, which means it logs all information at a level of INFO or more critical.

#### VoiceCheck Error Log

This log is a subset of the Honeywell log. It contains all information logged at a level of ERROR or more critical. This log is named according to the following naming convention:

VoiceCheck.err.n

where n is the number of the log.

## Logging Levels

Logs can be configured to record activities at one of the following levels, with TRACE being the least critical and FATAL the most critical:

- TRACE
- DEBUG
- INFO
- WARN
- ERROR
- FATAL

Logging configuration files set the logging level and the maximum size for logs. There are two logging configuration files, one for the Honeywell log and error log, and another for the Proxy log.

- The logging configuration file for the Honeywell log and the Honeywell error log is found here: `<installation path>\Honeywell\apache-tomcat-<version>\webapps\VoiceCheck\WEB-INF\classes\log4j.properties`

## Changing the Logging Level for a Log File

To change the logging level for one of these files, modify the threshold property and the root category. Examples of the affected parameters for each logging configuration file are shown below:

#### Honeywell Log and Error Log

- `log4j.rootCategory=WARN,voc`

This parameter specifies that these logs will report all information at a level of WARN or greater. If you want to view the log files at a lower level, you must change WARN to a lower logging level.

- `log4j.appender.voc.Threshold=INFO`  
`log4j.logger.com.Honeywell=INFO,voc_err`

These parameters specify the logging level for the Vocollect log. It is set to INFO. To log information at a different level in this file, you must change both of these parameters.

- `log4j.appender.voc_err.Threshold=ERROR`

This parameter specifies the logging level for the Vocollect error log. It will log information at a level of ERROR.

## Changing the Maximum File Size for a Log File

To change the maximum file size for any of the logs, modify the `maxFileSize` property. An example is shown below:

- `log4j.appender.voc.MaxFileSize=4MB`

You can also change the number of rollover files (files with a `.n` extension) by changing this parameter:

- `log4j.appender.voc.MaxBackupIndex=30`

## Device Logs

You can enable device logging in the VoiceConsole user interface to help troubleshoot problems and capture logs for Technical Support.

1. In VoiceConsole, select **Device Management > Devices**.
2. Select one or more devices in the table.
3. Click the **Manage devices > Enable logging for selected devices** action link.
4. After the issues have been captured, click the device name to view the device properties.
5. Export the log file from the View Device page.
6. Save the file and send it to Technical Support with relevant environment information:
  - Device and headset models
  - Honeywell software versions in use for VoiceCatalyst MI, VoiceConsole, and VoiceCheck
  - Date/time the issue first occurred
  - Frequency of the issue occurring
  - Impacts of the issue
  - Recent changes in the Honeywell Voice Maintenance & Inspection Solution environment

## Capture Device Logs

The fastest way to capture device logs for a specific issue is for the technician to speak the "Talkman report problem" command *when the problem occurs*. The system responds by sending a snapshot of the log file to VoiceConsole. The log can then be exported and sent to Technical Support.

To report a problem in Android, say **"I need help"** from any point in the application and select **Report a Problem**.

Reporting a problem sends logs from your device to the server. This includes:

**M&I application logs:** all files contained in the `/sdcard/Vocollect/logs` directory. Sub-directories are not included.

**Android logs:** all files contained in the `/storage/IPSM/logger` directory.

### **IMPORTANT**

The `/storage/IPSM/logger` directory is only available when the device logging is enabled. You can enable device logging from the Android device's **Settings** menu.

## **View Device Logs**

Open the Administration tab and select **Logs** from the navigation bar.

From the **Log Actions** list in the navigation bar, you can **View Server Logs**, **View Device Logs**, or **Save As Zip**.

Clicking server or device logs enables the **View Logs** list. From here you can click the name of a log to view that log.



# DATA TRANSMISSION

Web services are used to send transactional data between the host system and Honeywell VoiceCheck. VoiceCheck supports both SOAP and REST web services. These services provide the import and export functionality for the VoiceCheck system.

The services and message formats are described in detail below, and reference XML for the SOAP Web Service Description Language (WSDL) and REST Web Application Description Language (WADL) are provided in the product package. Descriptions of the services were previously viewable by entering <http://<host>:<port>/VoiceCheck/services/api/swagger.json> into your web browser. This link replaces the previously used link <http://<host>:<port>/VoiceCheck/services>.

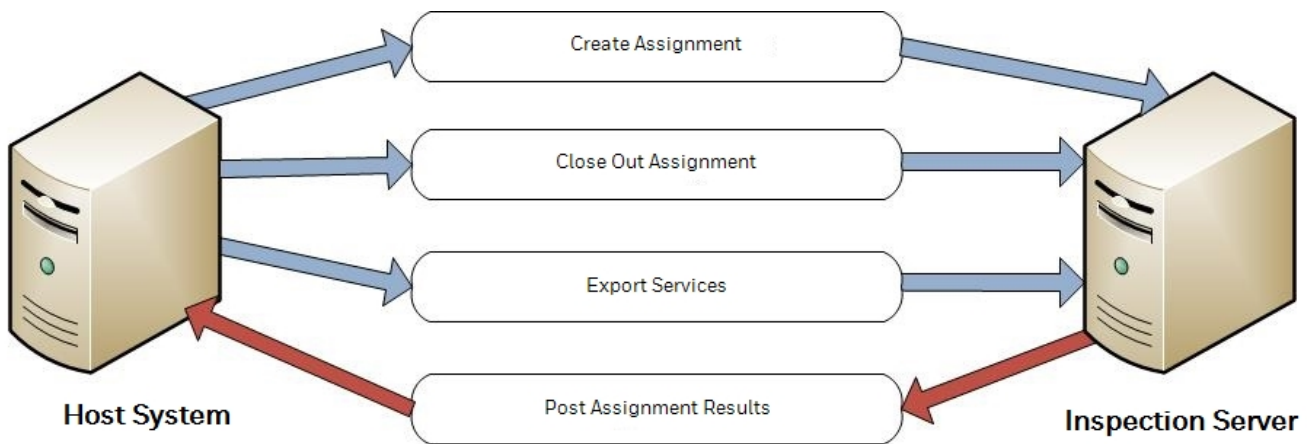

Web Services Message Flow

## Configuration and Security

All communications are performed over HTTP or HTTPS, depending on the configuration of VoiceCheck.

For data import, all SOAP web services provided by VoiceCheck require authentication with WS-Security UsernameToken. All REST web services for import require authentication using HTTP basic authentication.

VoiceCheck has an access role, configurable in the user interface, which determines a user's permissions to execute web services. The host system's web service clients must be configured to authenticate with VoiceCheck web services as a user with this role.

For data export, VoiceCheck supports using HTTP basic authentication to access a SOAP or REST web service on the host system. Authentication is optional but if used, it is configured in VoiceCheck, and the password is encrypted and stored in the VoiceCheck database.

VoiceCheck also provides a method to configure the service endpoint URL for services provided by the host system. This endpoint URL is a required setting in the GUI.

There is only one user name and password used to consume all services that the host system exposes for VoiceCheck. Currently, only one service is exposed for VoiceCheck to post assignment results to the host system.

The configuration information (service endpoint, web service client type, user name, and password) is set at the system level in VoiceCheck. These settings can be found on the **Administration > System Configuration** page. The configuration assumes that one instance of VoiceCheck will connect to a single host system endpoint.

## XML Schemas and Namespaces

VoiceCheck declares a namespace for all XML elements used in SOAP and REST services, with the exception of the faultInfo element (see note below). The namespace is:

```
http://service.web.voicecheck.vocollect.com/
```

For SOAP services that VoiceCheck provides for data import, you can find the namespace and schema in the WSDL.

For REST services that VoiceCheck provides for data import, you can find the namespace and schema in the WADL. Note that for the Create Assignment Web Service, REST clients do not have to qualify the XML with the namespace; however it is highly recommended.

For the REST service that VoiceCheck consumes to post assignment results to a host system, the namespace and schema that the server expects to see in the XML are defined in the example WADL provided in the product package.

### NOTE

The faultInfo element is not defined as part of a namespace. For REST services, VoiceCheck does not qualify the element with a namespace when sending it in an error response to a host system. Similarly, the host system **must not** qualify a faultInfo element with a namespace in a response to VoiceCheck.

## Fault Handling for Assignment Data

### REST Fault Handling

On failure, various HTTP status codes can be returned depending on the failure and where the failure occurred during processing. VoiceCheck makes use of the Apache® CXF framework for processing web services requests, and the framework can return errors during its processing such as 406 – Not Acceptable, or 415 – Unsupported Media Type, before the VoiceCheck business logic is reached.

Errors coming from the VoiceCheck business logic only have one of two status codes:

- 400 – Bad Request: The client has violated a business rule or constraint (usually bad data). Sending the message again without making a change to the content will result in the same error.
- 500 – Internal Server Error: There was an internal server error while processing the request. Retrying the message MAY result in success.

Also, errors coming from the VoiceCheck business logic include a faultInfo XML element containing additional information about the error that occurred. The properties of the faultInfo element are shown below.

## SOAP Fault Handling

SOAP 1.1 faults are returned for all errors. All faults contain a faultcode and faultstring as specified in SOAP 1.1. Two of the core SOAP 1.1 fault codes, Client and Server, are specified for most faults. VoiceCheck generally uses these codes in the manner described in the SOAP 1.1 specification.

There are errors that can occur during authentication that use fault codes specified in WS-Security (Web Services Security). The Java web services APIs and implementations may return other fault codes.

While it is not possible to list every fault code that may occur, there are general rules that can enable consistent handling of faults by web services clients:

- Fault codes other than Server typically mean that there is no point in automatically resending the message. They are sent when the client has done something wrong prior to the transmission reaching the application logic on the server, such as authentication failures or badly formed messages.
- When the fault code is Server, if the fault is coming from the application server logic, it will include the SOAP 1.1 fault detail element. The format is specified in the WSDL, but contains the information in the section below.

## Fault Info Element

Both REST and SOAP web services include the same error information when a fault comes from the VoiceCheck application server logic.

The host server REST implementation for post assignment results should use this fault info element in order to display the error message in the VoiceCheck GUI; otherwise, the user sees a generic message.

Property	Type	Definition
errorCode	long	Numeric code representing the error. Valid values: 3000 = Internal server error (request may or may not succeed on retry)

Property	Type	Definition
		3001 = Bad request (automated request retry is not recommended)
message	string	Human readable message explaining the error.

## VoiceForm Web Services

VoiceCheck exposes a web service that allows the creation of a VoiceForm—essentially a data import. This web service enables creating new VoiceForms as well as updating and deleting existing VoiceForms from the VoiceCheck server. When this web service is invoked, VoiceCheck validates the system for the following:

- If there is no matching VoiceForm name, a new VoiceForm is created.
- If there is a matching VoiceForm name, a new VoiceForm is not created.

A VoiceForm can be imported with or without any VoiceForm steps. This allows a technician to create the VoiceForm steps later, from the VoiceCheck server.

When VoiceCheck receives this message for reading, updating, and deleting of VoiceForms, the following validations are taken into consideration:

- If the VoiceForm name does not exist in VoiceCheck, no details are returned in the response.
- If the VoiceForm exists, the web service can update only the name of the VoiceForm.
- If the VoiceForm does not reference to any other entity in VoiceCheck, it can be deleted. Otherwise VoiceForm deletion is not permitted.

## Create VoiceForm Details

### REST Web Service

**WADL:** <http or https>://<host>:<port>/VoiceCheck/services/voiceform?\_wadl

**URL:** <http or https>://<host>:<port>/VoiceCheck/services/voiceform

**Method:** POST

**Content-Type:** application/json;charset=UTF-8

**Message Body:** JSON as outlined in the schema in the WADL. The elements are described in the input elements table.

**Response:** On success, HTTP Status 200 with Payload “VoiceForm saved”. On failure, the system returns an error. Any HTTP status code other than 200 or 204 is considered an error. When possible, the host system should return a body for errors.

### POST Parameters

A VoiceForm file with valid parameters in the body.

## READ VOICEFORM DETAILS

### REST WEB SERVICE

**WADL:** <http or https>://<host>:<port>/VoiceCheck/services/voiceform?\_wadl

**URL:** <http or https>://<host>:<port>/VoiceCheck/services/voiceform/{voiceformname}

**Method:** GET

**Content-Type:** application/json;charset=UTF-8

**Response:** On success, HTTP Status 200 with or without a body. On failure, the system returns an error.

## UPDATE VOICEFORM DETAILS

**WADL:** <http or https>://<host>:<port>/VoiceCheck/services/voiceform?\_wadl

**URL:** <http or https>://<host>:<port>/VoiceCheck/services/voiceform/update/{voiceformname}/  
{newvoiceformname}

**Method:** POST

**Content-Type:** application/json;charset=UTF-8

**Response:** On success, HTTP Status 200 with or without a body. On failure, the system returns an error.

## DELETE VOICEFORM DETAILS

**WADL:** <http or https>://<host>:<port>/VoiceCheck/services/voiceform?\_wadl

**URL:** <http or https>://<host>:<port>/VoiceCheck/services/voiceform/{voiceformname}

**Method:** DELETE

**Response:** On success, HTTP Status 200 with or without a body. On failure, the system returns an error.

## Manage Images

### REST WEB SERVICE

**WADL:** <http or https>://<host>:<port>/VoiceCheck/services/imageService?\_wadl

**URL:** <http or  
https>://<VoiceCheckIP>:<port>/VoiceCheck/services/imageService/<Directory/Folder  
Name><Directory/Folder Name>.....<photo filename with extension>

**Method:** GET

**Parameter:** image path in the file system with image name (parameter is sent in the URL)

**Content-Type:** (blank)

**Response:** On success, HTTP Status 200. When photo is not found, the service generates a `WebApplicationException` with status HTTP Status 404 Not Found.

**Basic Authentication:** VoiceCheck User Name and Password

## INPUT ELEMENTS

PROPERTY	TYPE	REQ'D	DEFINITION	VALIDATION
voiceformname	String	Yes	The name of the VoiceForm	Must be unique in VoiceCheck

# VoiceForm Version Web Services

## Create VoiceForm Version

### REST Web Service

**WADL:** <http or https>://<host>:<port>/VoiceCheck/services/voiceformVersion?\_wadl

A VoiceForm version can be created using 2 ways:

1. *Without* specifying the version number.

**URL:** <http or https>://<host>:<port>/VoiceCheck/services/voiceformVersion/import/

In this case the version the version required to be created is not specified in the URL. So the system will publish a new version and assign it number, which +1 of the last added version

2. With VoiceForm version number specified

**URL:** <http or https>://<host>:<port>/VoiceCheck/services/voiceformVersion/import/{voiceFormVersion}/

Here {voiceFormVersion} is specified and the system will publish the requested VoiceForm with the version number specified, only if it is available and not already assigned to any other version.

**Method:** POST

**Content-Type:** application/json;charset=UTF-8

**Message Body:** JSON as outlined in the schema in the WADL. The elements are described in the input elements table.

**Response:** On success, HTTP Status 200 with Payload “VoiceForm version saved”. On failure, the system returns an error. Any HTTP status code other than 200 or 204 is considered an error. When possible, the host system should return a body for errors.

### POST Parameters

A VoiceForm file with valid parameters in the body.

## READ VOICEFORM Version

### REST WEB SERVICE

**WADL:** <http or https>://<host>:<port>/VoiceCheck/services/voiceformVersion?\_wadl

**URL:** <http or https>://<host>:<port>/VoiceCheck/services/voiceformVersion/export/<FORMNAME>/<FORM-VERSION>

**Method:** GET

**Content-Type:** application/json;charset=UTF-8

**Response:** On success, HTTP Status 200 with or without a body. On failure, the system returns an error.

## INPUT ELEMENTS

PROPERTY	TYPE	REQ'D	DEFINITION	VALIDATION
voiceFormVer	String	No	Version of VoiceForm existing in the system	If specified, the value must match an existing VoiceForm version.

## Import/Export Operators

There are two REST web services available to import and export operator data.

### Import Operators

Input parameters:

- Operators.ZIP
- Site Name

Operators.ZIP can contain one or more folders. Each folder needs:

- OperatorId.json file
- Voice templates ZIP file that contains all the trained words of the operator

When importing a single operator, `operatorId` is the only parameter needed. No parameter is required when importing multiple operators.

Both new and existing operators can be created using REST.

## Response codes

**200 OK:** import of all operators was successful

**400 Bad Request:** content of the ZIP file is invalid

**207 Multi-Status:** some operators were imported and some were not. The error message contains information for all operators that were not imported.

## Export Operators

**URL (single operator):** `http://serverip:port/VoiceCheck/services/operator/{operatorId}`

where `operatorId` is the login name of the operator; for example, operator `tsmith` would be:

`http://serverip:port/VoiceCheck/services/operator/{tsmith}`

**URL (all operators):** `http://serverip:port/VoiceCheck/services/operators/`

### NOTE

To export more than one operator, but not all operators, call the export single operator rest service  $n$  number of times.

**Method:** (GET), Content Type (application/json;charset=UTF-8)

### Response

Success: HTTP Status 200 with or without a body

Failure: the system returns an error

**Result:** A zip file containing the operator data.

## Content and format of Import/Export files

The file must be in ZIP format. The ZIP file contains the same number of folders as there are operators. For instance: if five operators are being imported or exported, the zip file would contain five folders, one for each operator.

Each folder contains:

1. An `operator.json` file: this file contains operator information including operator id, name, and email along with an encrypted password and access code. Example: `ben.json`
2. A zip file that includes all templates for that operator. The name of the zip file is "`operatorID_templates.zip`" (Example: `ben_templates.zip`)
  - This zip file contains `.bt2` files, which are template files for the operator
  - Format for the name of `.bt2` file would be "`Language_operator_vocab.bt2`" (For example: `%en-US%_ben_alpha.bt2`)



# Import/Export Steps

A REST web service is available to import and export steps.

## Import Steps

### MockServer

Steps can be imported into the VoiceCheck server using MockServer. To perform this action, copy the file from the examples directory (Steps.json) to Mock server\REST\Default\ImportSteps folder.

### CURL

Following command can be used to import steps into the VoiceCheck server.

```
curl -v -X POST http://serverip:port/VoiceCheck/services/steps/import/{voiceFormName} -F "steps=@pathToJSONfile/abc.json" --user "admin:Talkman1" -H "Content-Type: application/octet-stream"
```

For example:

```
curl -v -X POST http://172.31.42.241:9080/VoiceCheck/services/steps/import/test%20form -F "steps=@curl new.json" --user "admin:Talkman1" -H "Content-Type: application/octet-stream"
```

### Postman

1. Select the method type as **POST**
2. URL `http://serverip:port/VoiceCheck/service/steps/import/{VoiceFormName}`  
Voice Form Name in the above URL is voice form to which steps need to imported
3. Select the **Authorization** tab, and select type as “Basic Auth”.
4. Provide valid username and password
5. Select the **Headers** tab, after Authorization header will be automatically filled.
6. Add header with key as “Content-Type” and values as “application/octet-stream”
7. Select the **Body** tab, select form-data checkbox and add key “steps” and in the dropdown next to it select “File” and browse steps.json and click “Send”

## Export Steps

### MockServer

Existing steps can be exported from the VoiceCheck server using this feature. To do so, copy the file from the examples directory (ReadSteps.json) to Mock server\REST\Default\ReadSteps. The exported file should get stored in Mock server\REST\ReadStepsResponse folder as a timestamped file (steps\_timestamp.json).

### CURL

Following command can be used to export steps from the VoiceCheck server

## VoicePlan Web Services

VoiceCheck exposes a web service that allows the creation of a VoicePlan—essentially a data import. This web service enables creating new VoicePlans as well as updating and deleting existing VoicePlans from the VoiceCheck server. When this web service is invoked, VoiceCheck validates the system for the following:

- If there is no matching VoicePlan name, a new VoicePlan is created.
- If there is a matching VoicePlan name, a new VoicePlan is not created.
- A VoicePlan without Description, VoiceForm and Section Steps is considered invalid and not created.
- A VoicePlan is not created if the VoiceForm associated with the VoicePlan is not found in the VoiceCheck server.

When VoiceCheck receives this message for reading, updating, and deleting of VoicePlans, the following validations are taken into consideration:

- If the VoicePlan name does not exist in VoiceCheck, no details are returned in the response.
- If the VoicePlan exists, the web service can update only the name of the VoicePlan.
- A VoicePlan can be deleted even if it references to some entity in VoiceCheck.

### Create VoicePlan Details

#### REST Web Service

**WADL:** <http or https>://<host>:<port>/VoiceCheck/services/voiceplan?\_wadl

**URL:** <http or https>://<host>:<port>/VoiceCheck/services/voiceplan

**Method:** POST

**Content-Type:** application/json;charset=UTF-8

**Message Body:** JSON as outlined in the schema in the WADL. The elements are described in the input elements table.

**Response:** On success, HTTP Status 200 with Payload “VoicePlan saved”. On failure, the system returns an error. Any HTTP status code other than 200 or 204 is considered an error. When possible, the host system should return a body for errors.

#### POST Parameters

A VoicePlan file with valid parameters in the body.

### READ VoicePlan DETAILS

#### REST WEB SERVICE

**WADL:** <http or https>://<host>:<port>/VoiceCheck/services/voiceplan?\_wadl

**URL:** <http or https>://<host>:<port>/VoiceCheck/services/voiceplan/{planIdentifier}

**Method:** GET

**Content-Type:** application/json;charset=UTF-8

**Response:** On success, HTTP Status 200 with or without a body. On failure, the system returns an error.

## UPDATE VoicePlan DETAILS

**WADL:** <http or https>://<host>:<port>/VoiceCheck/services/voiceplan?\_wadl

**URL:** <http or https>://<host>:<port>/VoiceCheck/services/voiceplan/update/

**Method:** POST

**Content-Type:** application/json;charset=UTF-8

**Response:** On success, HTTP Status 200 with or without a body. On failure, the system returns an error.

### POST Parameters

A VoicePlan file with updated parameters in the body.

## DELETE VoicePlan DETAILS

**WADL:** <http or https>://<host>:<port>/VoiceCheck/services/voiceplan?\_wadl

**URL:** <http or https>://<host>:<port>/VoiceCheck/services/voiceplan/{planIdentifier}

**Method:** DELETE

**Response:** On success, HTTP Status 200 with or without a body. On failure, the system returns an error.

## INPUT ELEMENTS

PROPERTY	TYPE	REQ'D	DEFINITION	VALIDATION
planIdentifier	String	Yes	The name of the VoicePlan	Must be unique in VoiceCheck

## Assignment Web Services

VoiceCheck exposes a web service that allows the creation of an—essentially a data import. This web service enables creating new assignments as well as updating and deleting of existing assignments from the VoiceCheck server.

An assignment specifies a list of sections to perform, and each section contains a list of steps to perform. Each step references a voice-enabled step definition from a VoiceForm.

This service can be used for assignment updates as well as creating new assignments. When VoiceCheck receives this web service message, it checks for existing matches in the system:

- If there is no matching assignment ID and no matching work ID in the system, a new assignment is created.
- If there is a matching assignment ID and the existing assignment is in available status (the assignment has not been started in VoiceCheck), the existing assignment is replaced. If the assignment is in any other state, the import fails.
- If there is no matching assignment ID but there is a matching work ID and the assignment associated with that work ID is in complete status, the existing assignment is replaced. If the existing assignment is in any other status, the import fails. This validation allows for reusing work IDs for assignment updates.

When VoiceCheck receives this message for reading, updating, and deleting of assignments, the following validations are taken into consideration:

- Verify that assignment in progress cannot be deleted using REST over an http server
- Verify that assignment assigned to an operator and not initiated yet should get deleted using REST over an http server
- Verify that assignment in Available state and not assigned to any operator can be deleted using REST over an http
- Verify that a 100% completed assignment cannot be deleted using REST over an http
- Verify that a closed out assignment can be deleted using REST over http server
- Verify that a Re-opened assignment cannot be deleted using Rest over an http server
- Verify that assignment progress is captured using REST over an http server

VoiceCheck prompts technicians to perform each section in the order listed in the sectionsToPerform field and prompts for the steps according to the sequence specified by the sequenceCounter property. Steps may be sent in any order in the web service message; VoiceCheck orders them based on the sequenceCounter property.

## Create Assignment Details

### REST Web Service

**WADL:** <http or https>://<host>:<port>/VoiceCheck/services/assignments?\_wadl

**URL:** <http or https>://<host>:<port>/VoiceCheck/services/assignments

**Method:** POST

**Message Body:** XML as outlined in the schema in the WADL, the elements of which are described in the tables below.

**Response:** On success, HTTP Status 204 (No Content) with an empty body. On failure, the system returns an error. See "Fault Handling for Assignment Data" on page 114 for more information. for more detail.

## SOAP Web Service

**WSDL:** <http or https>://<host>:<port>/VoiceCheck/services/AssignmentService?wsdl

**Service Endpoint:** <http or https>://<host>:<port>/VoiceCheck/services/AssignmentService

**Operation:** createAssignment

**Input:** A single Assignment object, as described in the tables below.

**Output:** On success, the system returns an empty response as defined in the WSDL. On failure, the system returns an error. See "Fault Handling for Assignment Data" on page 114 for more information. for more detail.

## READ Assignment DETAILS

### REST WEB SERVICE

**WADL:** <http or https>://<host>:<port>/VoiceCheck/services/assignments?\_wadl

**URL:** <http or https>://<host>:<port>/VoiceCheck/services/assignments/Default/{assignmentId}

**Method:** GET

**Content-Type:** application/json;charset=UTF-8

**Response:** On success, HTTP Status 200 with or without a body. On failure, the system returns an error.

## DELETE Assignment DETAILS

### REST WEB SERVICE

**WADL:** <http or https>://<host>:<port>/VoiceCheck/services/assignments?\_wadl

**URL:** <http or https>://<host>:<port>/VoiceCheck/services/assignments/Default/{assignmentId}

**Method:** DELETE

**Response:** On success, HTTP Status 200 with or without a body. On failure, the system returns an error.

## Input Elements

Assignment: Header				
Property	Type	Req'd	Definition	Validation
siteName	string	yes	The site name.	Must match an existing site name in VoiceCheck.
assignmentId	string	yes	Unique identifier for this assignment within the specified site.	Must be unique for every

Assignment: Header				
Property	Type	Req'd	Definition	Validation
				assignment in VoiceCheck, unless web service record is updating an existing assignment in Available status.
worldId	string	yes	Unique identifier that a user will enter to request the work.	Must be unique for every assignment in VoiceCheck.
metadata	list of key-value pairs	no	A list of additional, pass-through information about the assignment that will be sent back to the host system in the Post Assignment Results message.	No validation. VoiceCheck does not use this pass-through data.
operatorId	string	no	Unique identifier of the technician that will be associated with this assignment.	If specified, the value must match an existing operator ID.
voiceFormName	string	yes	The name of the VoiceForm from which to look up the voice-enabled step definitions for the stepsToPerform.	Must match an existing VoiceForm name in VoiceCheck.
voiceFormVer	String	No	Version of VoiceForm existing in the system	If specified, the value must match an existing VoiceForm version.
sectionsToPerform	list of section objects	yes	A list of sections to perform, sorted in the order they should be performed. See Section definition below.	At least one section must be specified.
Assignment: Section				
Property	Type	Req'd	Definition	Validation
sectionId	string	yes	An identifier for the section. The sectionId must be unique within the assignment.	Must be unique within the assignment.
sectionDescription	string	yes	Description of the section to be performed. This VoiceApplication speaks this value as the description of the section when a technician starts a new section in the workflow.	
sectionIsPart	boolean	yes	Operations on the host system are categorized as either being a part or not being a part. If the operation is a part, this field contains a value of true; otherwise it is false. Sections that are parts have custom behavior associated with them.	
partNumber	comma separated list	no *	The part number. If there are multiple known part numbers for the same part, they must be sent in a comma separated list (no spaces) in this field. For example:	

Assignment: Section				
Property	Type	Req'd	Definition	Validation
			100234,100345,100456	
			<div style="border: 1px solid green; padding: 5px;"> <p><b>TIP</b> If the inspection material is expected to contain more than one of the same part, you must create two <i>identical</i> part sections (with the same partNumber entry) in the assignment.</p> </div>	
			* Required when sectionIsPart = true.	
partDescription	string	no *	The part name.	
			* Required when sectionIsPart = true.	
stepsToPerform	list of step objects	yes	A set of steps to perform, sent in any order See Step definition below.	At least one step must be specified.
loop	Boolean	No	Determines if the section is a looping section	Can only be true/false.
loopingPrompt	String	No	Message shown to user to confirm whether they want to do another looping iteration of this section	If "loop" = true "loopingPrompt" must have a text value (not null or "")

Assignment: Step				
Property	Type	Req'd	Definition	Validation
sequenceCounter	numeric string	yes	Unique number assigned to the step to determine the order in which the step is performed within the section.  The system converts this value to a number for ordering the steps.	Must be numeric.  Must be unique within the section.
stepId	string	yes	An identifier for the step to perform from the VoiceForm.	Must exist in the VoiceForm referenced by this assignment.
isMandatory	boolean	yes	A flag that indicates if this step is mandatory. Valid values:  true = step is mandatory  false = step is not mandatory	Must contain one of the valid values.

Assignment: Step				
Property	Type	Req'd	Definition	Validation
			Note that if a step is set as mandatory, the VoiceApplication will not allow a technician to respond with "does not apply."	
promptData	list of key-value pairs	no	A list of values to be substituted for variable tokens in this step's prompt and help message.	No validation.
metadata	list of key-value pairs	no	A list of additional, pass-through information about the step that will be sent back to the host system in the Post Assignment Results message.	No validation. VoiceCheck does not use this pass-through data.

**Additional validation rules:** The createAssignment import messages are subject to additional validation rules for dependent steps and display IDs. VoiceCheck verifies each step to be imported against the existing VoiceForm step definitions to validate that:

- If a step references another step as a display ID, that reference step is found in the assignment import,
- If a step has conditions that are dependent on another step, that reference step is found in the assignment import and follows the rules for step dependencies. See the Honeywell Voice Inspection Solution Administrator's Guide for rules for step dependencies.

## Rules for Step Dependencies

The inspection plan sent from the host system must adhere to a set of rules so that the VoiceApplication can determine how to link dependent steps to steps referenced in condition statements.

The rules are especially important because a plan can contain many instances of a single step—all with the same step ID but with potentially different dependent steps or with no dependencies at all.

## Step Occurrence in Inspection Plans

- A reference step must appear before its dependent step in assignment. If the dependent step refers to a reference step that occurs later in the assignment, the dependent step is skipped.
- If a reference step cannot be found in the inspection plan, the VoiceApplication ignores the conditions and executes the dependent steps.
- If the reference step ID occurs only once in the inspection plan, the reference step can be in any non-parts section while the dependent step(s) appear in any section. Reference step IDs in parts sections can only be referenced by dependent steps in the same parts section.
- If the reference step ID occurs multiple times in the inspection plan, the reference step must be in the same section as its dependent step and must be the only instance of that step ID within that section.



Sample Inspection Plan: Single Reference Step in Plan; Defined before Any Dependent Steps	Sample Inspection Plan: Single Reference Step and Dependent Steps Confined within Parts Section	Sample Inspection Plan: Multiple References; Dependencies Confined within Sections
<u>Section I</u> <b>Step A (reference)</b> Step B Step C	<u>Section I</u> Step B Step C	<u>Section I</u> <b>Step A (reference)</b> <b>Step D (dependent)</b> Step A
<u>Section II</u> <b>Step D (dependent)</b> Step C Step E Step C	<u>Section II</u> Step E Step F	<u>Section II</u> <b>Step A (reference)</b> <b>Step D (dependent)</b> Step B
<u>Section III</u> Step E <b>Step D (dependent)</b>	<u>Parts Section I</u> <b>Step A (reference)</b> Step E <b>Step D (dependent)</b> Step C <b>Step D (dependent)</b>	<u>Section III</u> Step A Step E
<u>Parts Section</u> <b>Step D (dependent)</b>	<u>Parts Section II</u> Step E Step C	<u>Parts Section</u> <b>Step A (reference)</b> <b>Step D (dependent)</b> Step G

## Close Assignment Web Service

VoiceCheck exposes a web service that allows an assignment to be closed out. This message is called by the host system when the usage decision is made for an inspection lot and sent in order to close out an assignment in VoiceCheck.

When an assignment is closed out, its status changes to Complete. Any remaining steps are left in their current status. No results are transmitted for this assignment while it is being closed out or after close.

# Close Assignment Details

## REST Web Service

**WADL:** <http or https>://<host>:<port>/VoiceCheck/services/assignments?\_wadl

**URL:** <http or https>://<host>:<port>/VoiceCheck/services/assignments/{siteName}/{assignmentId}/status

The {siteName} and {assignmentId} are path parameters, the values of which should be URL encoded.

**Method:** POST

**Message Body:** XML as outlined in the schema in the WADL, the elements of which are described in the table below.

**Response:** On success, HTTP Status 204 (No Content) with an empty body. On failure, the system returns an error. See "Fault Handling for Assignment Data" on page 114 for more information. for more detail.

## Input Details – REST

Path parameters:

- {siteName} - The name of the site. The system validates that the parameter matches an existing site name in the system.
- {assignmentId} - A unique identifier for the assignment to close. The system validates that the parameter matches an existing assignment ID in the system.

### Close Assignment

XML Element	Req'd	Definition
assignmentStatus	yes	The only valid value for this element is "complete." Example entry: <assignmentStatus>complete</assignmentStatus>

## SOAP Web Service

**WSDL:** <http or https>://<host>:<port>/VoiceCheck/services/AssignmentService?wsdl

**Service Endpoint:** <http or https>://<host>:<port>/VoiceCheck/services/AssignmentService

**Operation:** createAssignment

**Input:** A single Assignment object, as described in the tables below.

**Output:** On success, the system returns an empty response as defined in the WSDL. On failure, the system returns an error. See See "Fault Handling for Assignment Data" on page 114 for more information. for more detail.

### Input Details – SOAP

Close Assignment				
Property	Type	Req'd	Definition	Validation
siteName	string	yes	The name of the site.	Must match an existing site name in the system.
assignmentId	string	yes	Unique identifier for the assignment to close.	Must match an existing assignment ID in the system. The assignment cannot be In-progress with a technician actively working on it.

## Post Assignment Results Web Service

VoiceCheck consumes a web service exposed by the host system in order to post results—essentially a data export. For a given assignment, this message can be sent multiple times. It is sent each time a user submits results through the VoiceCheck graphical user interface (GUI). It includes results for any steps that have a status of "complete" or "does not apply" at the time of submission and that have not already been submitted to the host system.

In order to use this export functionality, the host system must implement a REST or SOAP web service according to the details specified below. VoiceCheck includes both REST and SOAP web service clients that can consume a service built according to the specifications below. For SOAP, the PostAssignmentResults.wsdl WSDL document included in the product package details the contract that the SOAP service must implement. For REST, an example WADL is included in the product package as a reference for implementers developing a REST service.

Note that for REST, the specification is slightly more flexible than what is detailed in the example WADL. In fact, there is no requirement to even use a WADL as long as the service behaves as specified below.

### REST Web Service

**URL:** Completely flexible, can be decided by each server implementation.

The URL can specify either http or https. The VoiceCheck client uses the transport corresponding to the protocol specified. Configure the URL as the **Service Endpoint** on the **Administration > System Configuration** page of the user interface.

Example: <http or https>://<server>/assignmentResults

**Authentication:** HTTP Basic Authentication is supported but not required. Turn authentication on for the VoiceCheck client by checking the **Requires Authentication** checkbox on the **Administration > System Configuration** page of the user interface.

**Method:** POST

**Content-Type:** application/xml;charset=UTF-8

The VoiceCheck client always sends the results content using this content type, so the host server implementation must accept this content type.

**Message Body:** XML as outlined in the schema in the WADL, the elements of which are described in the tables below.

**Response:** On success, HTTP Status 204 (No Content) with an empty body. It is also acceptable for the service to return HTTP Status 200 (Success), with or without a body. If the VoiceCheck client receives a body, it will be ignored.

When returning content, the server should use the content-type: application/xml;charset=UTF-8

Any HTTP status code other than 200 or 204 is considered an error. When possible, the host system should return a body for errors containing a faultInfo element. The information in the faultInfo element will be used to provide additional details about the error to the GUI user. See "Fault Handling for Assignment Data" on page 114 for more information. for more detail.

## SOAP Web Service

**WSDL:** You must build a server that implements the PostAssignmentResults.wsdl as provided by Honeywell. The input details below describe the data elements in this WSDL.

**Service Endpoint:** Completely flexible, can be decided by each server implementation.

The URL can specify either http or https. The VoiceCheck client uses the transport corresponding to the protocol specified. Configure the URL as the service endpoint on the **Administration > System Configuration** page of the user interface.

Example: <http or https>://<server>/AssignmentResultsService

**Authentication:** HTTP Basic Authentication is supported but not required. Turn authentication on for the VoiceCheck client by checking the **Requires Authentication** checkbox on the **Administration > System Configuration** page of the user interface.

**Fault Handling:** The server may return any SOAP fault. If the server returns the WebServiceException fault specified in the WSDL, the message contained in the WebServiceException will be displayed as part of the error message in the VoiceCheck GUI. All other faults will trigger a generic error message in the GUI.

## Input Details

Assignment Results: Header			
Property	Type	Req'd	Definition
siteName	string	yes	The site name.
assignmentId	string	yes	The assignmentId that was sent from the host system to VoiceCheck in the Create Assignment message.
workId	string	yes	The workId that was sent from the host system to VoiceCheck in the Create Assignment message.
user	string	yes	The VoiceCheck GUI user who submitted the results.
timeSubmitted	datetime	yes	The time that the user submitted the results to the external system. Data type: XML schema xs:dateTime type. Format: valid xs:dateTime string value indicating the time in UTC: YYYY-MM-DDThh:mm:ss.sssZ Example: 2014-06-14T19:27:33.152Z
metadata	list of key-value pairs	no	A list of additional, pass-through information about the assignment that was sent in the Create Assignment message.
sectionResults	list section results	yes	List of section results defined in the following table.
Assignment Results: Section Results			
Property	Type	Req'd	Definition
sectionId	string	yes	An identifier for the section that was sent from the host system in the Create Assignment message.

### Assignment Results: Section Results

Property	Type	Req'd	Definition
stepResults	list of step results	yes	List of step results defined in the following table.

### Assignment Results: Step Results

Property	Type	Req'd	Definition
sequenceCounter	numeric string	yes	The sequenceCounter sent for the step in the Create Assignment message.
stepId	string	yes	The identifier of the step that was performed from the VoiceForm. This value matches the stepId that was sent for the step in the Create Assignment message.
user	string	yes	Voice inspection user name or technician who last updated the result.
metadata	list of key-value pairs	no	A list of additional, pass-through information about the step that was sent in the Create Assignment message.
startTime	datetime	yes	<p>The date and time that the step was started in the voice application by the device operator.</p> <p>Data type: XML Schema xs:dateTime type</p> <p>Format: valid xs:dateTime string value indicating the time in UTC: YYYY-MM-DDThh:mm:ss.sssZ</p> <p>Example: 2014-06-14T19:27:33.152Z</p> <p>Results that are system-generated, such as a dependent step marked "does not apply," do not include a start time.</p>

## Assignment Results: Step Results

Property	Type	Req'd	Definition
			<p><b>NOTE</b> The startTime and endTime may not always reflect the actual time spent performing the step because the voice application provides technicians with functions such as skipping steps and redoing steps.</p>
endTime	datetime	yes	<p>The date and time that the step was completed in the voice application by the device operator.</p> <p>Data type: XML Schema xs:dateTime type.</p> <p>Format: valid xs:dateTime string value indicating the time in UTC: YYYY-MM-DDThh:mm:ss.sssZ</p> <p>Example: 2014-06-14T19:27:33.152Z</p> <p><b>NOTE</b> The startTime and endTime may not always reflect the actual time spent performing the step because the voice application provides technicians with functions such as skipping steps and redoing steps.</p>
status	integer	yes	<p>An integer value describing the final status of the step.</p> <p>Valid values:</p> <p>2 = Does not apply</p> <p>3 = Complete</p>
results	list of strings	no	<p>A list of results for the step. Each result is specified as a result element containing a string.</p> <p>When the status is "2" (does not apply), no</p>

## Assignment Results: Step Results

Property	Type	Req'd	Definition
			<p>results are sent (the XML does not contain any results elements).</p> <p>When the status is "3" (complete), results may be sent or not, depending on the step type. See the "Results for Completed Steps" table below.</p>

## Results for Completed Steps

Step Type (from VoiceForm)	Description
Prompt Only	No results sent.
Ready	No results sent.
Notes	Zero or more results sent. One result is sent for each transcription that is not blank. If all notes for a step have blank transcriptions, no results are sent.
Multiple List Selection	One or more results sent. One result is sent for each selection made at the prompt. The value of each result will be the key from the VoiceForm that represents the selection made.
Float Value	One result sent. The result is the value spoken by the user.
Value Entry	One result sent. The result is the value spoken by the user.
Long Value Entry	One result sent. The result is the value spoken by the user.
Fraction	One result sent. The result is the value spoken by the user.
Date	One result sent. The result is the value spoken by the user and formatted as per the date format specified in the VoiceForm.



## Results for Completed Steps

Step Type  
(from  
VoiceForm)

Description

Photos

One or more results sent. One result is sent for each photo taken. The value of each result will be the URL that can be used by an external system to retrieve the photo using the Get Photo Web Service.

Part Number

One result sent. The result is the value chosen or spoken by the user.

## Assignment Export

There are three REST web services available to PULL data from assignment exports.

### Get Available Exports

**URL:** `http://<voice_check_server_name:port>/VoiceCheck/services/exports`

A username and password must be provided.

**Method:** GET

**Result:** A JSON list of IDs from VoiceCheck that are ready to be exported, in the following format:

```
[  
  {"id": "<id_1>"},  
  {"id": "<id_2>"},  
  ...  
  {"id": "<id_N>"}  
]
```

### Get An Export

**URL:** `http://<voice_check_server_name:port>/VoiceCheck/services/exports/<export_id>`

**Method:** GET

**Result:** The assignment's export data.

### Mark Export as Received

Used to tell VoiceCheck that the data was received from **Get An Export** and is OK.

**URL:** `http://<voice_check_server_name:port>/VoiceCheck/services/exports/<export_id>`

The <export id> is the same ID used in **Get An Export**.

**Method:** POST

**NOTE**

Any exports marked as received using **Mark Export as Received** will not be returned for **Get Available Exports**. However, an export can still be accessed directly using its id in **Get an Export**.

## Get Photo Web Service

When an inspection step result includes photo files that are posted to the VoiceCheck server, the assignment results data that is exported to the host system contains URLs for retrieving those files. Users will have to log in using their VoiceCheck credentials to view these URLs/photos from the browser. These photo files will be purged from VoiceCheck according to the purge schedule set in the **System Configuration** GUI page, so the host system would have to retrieve them before they are purged.

VoiceCheck exposes a REST web service for Get Photo. The GET request is a URL that contains the filename of a photo. All parameters are contained in the URL.

### REST Web Service

**Action:** getPhoto

**URL:** <http or https>://<VoiceCheck IP>:<port>/VoiceCheck/services/photos/<Device.Id>\_<photo filename>.jpg

Example: http://localhost:8090/VoiceCheck/services/photos/12345678\_150519085225.jpeg

**Method:** GET

**Parameter:** photoName (parameter is sent in the URL)

**Content-Type:** (blank)

**Response:** On success, HTTP Status 200. When photo is not found, the service generates a WebApplicationException with status HTTP Status 404 Not Found.

**Basic Authentication:** VoiceCheck User Name and Password

Alternatively, if the host system has access to the photos folder on the VoiceCheck server, it can copy the photo files directly over the network.

# MAINTENANCE & INSPECTION VERSION HISTORY

Release Notes for each version of VoiceConsole are available at [www.help.honeywellaidc.com](http://www.help.honeywellaidc.com).

Version	Release Date
1.8	January 2021
1.7.1	December 2019
1.7	April 2019
1.6	May 2018
1.5	November 2017
1.4	June 2017
1.3	May 2017
1.2	November 2016
1.1	November 2015

Honeywell  
9680 Old Bailes Road  
Fort Mill, SC 29707

[www.sps.honeywell.com](http://www.sps.honeywell.com)