

START A SHIFT - WIRED HEADSET

6. Select device

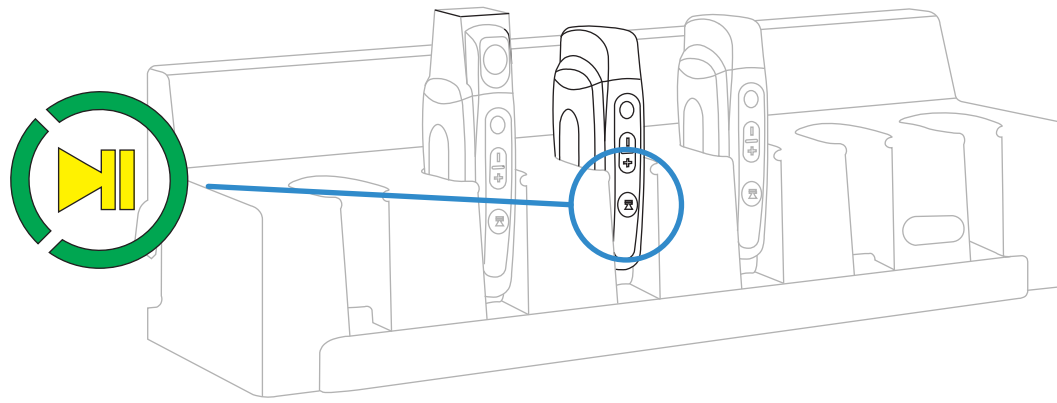

7. Put on headset and position microphone

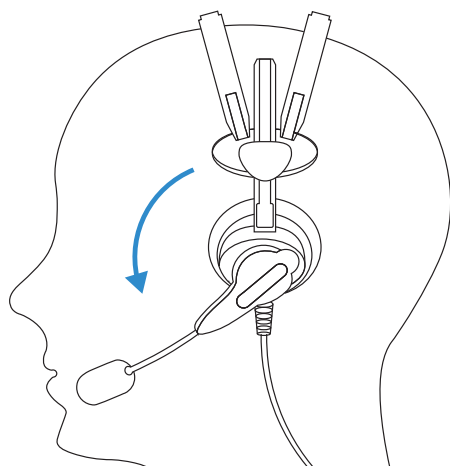

1" (2cm) from
corner of mouth

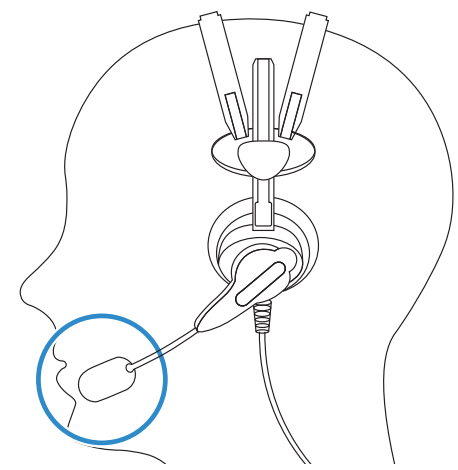

8. Fasten cable clips

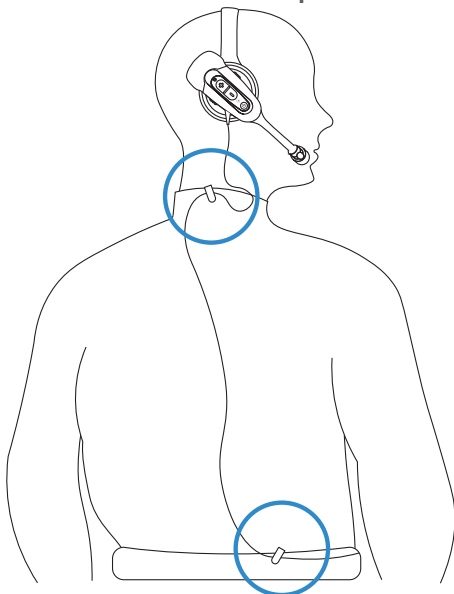

9. Match port colors

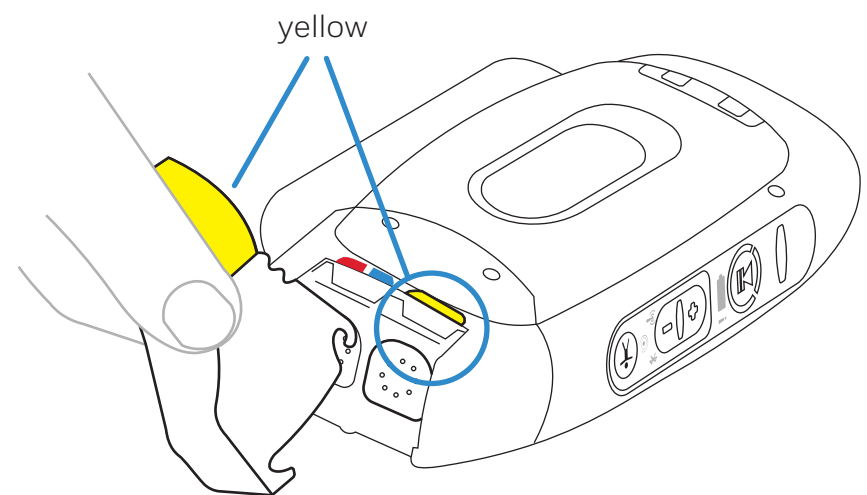

10. Tilt connector toward device until it clicks

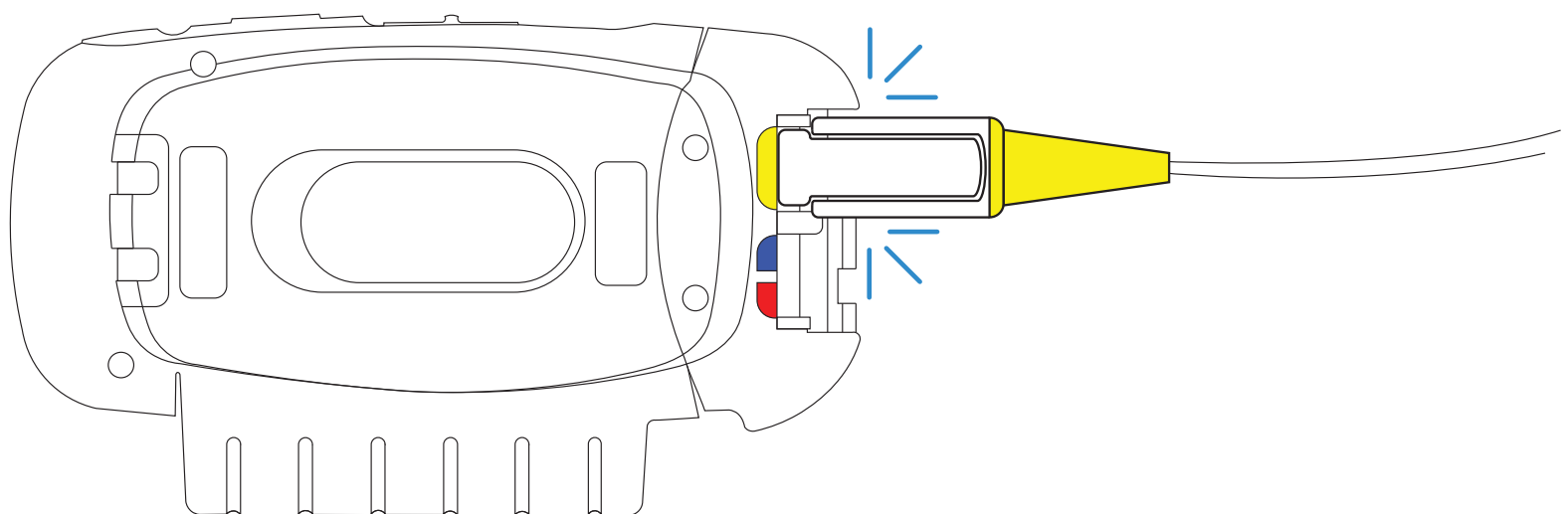

END A SHIFT - WIRED HEADSET

1. Power off device

Press and hold Play/Pause until LED rotates red

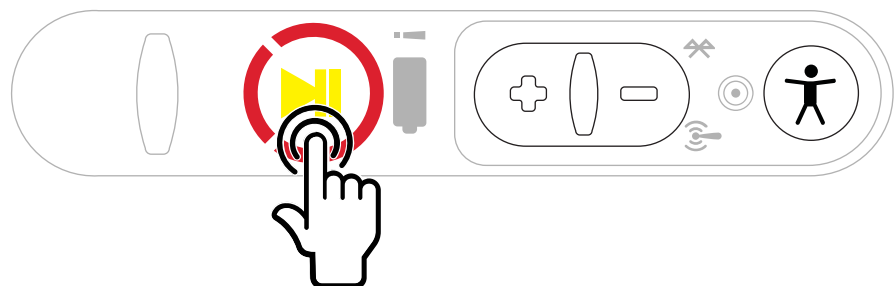

2. Remove connector

Grasp connector, tilt bottom of connector away from device and lift up

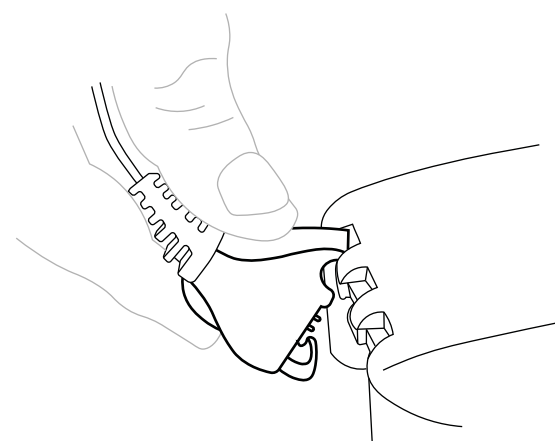

3. Slide out holster

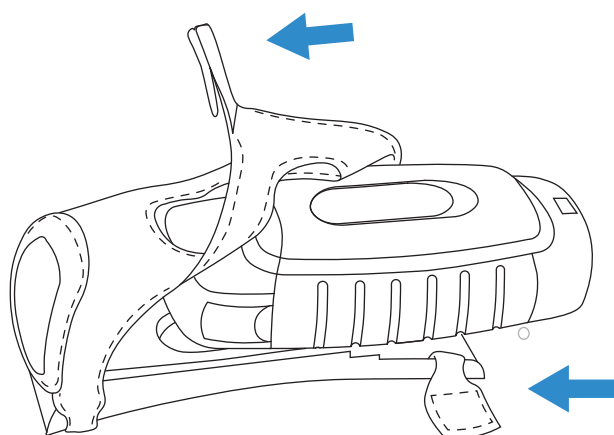

Open Velcro® and slide device out

4. Insert into slot

Insert device with button controls facing out and Operator button on top

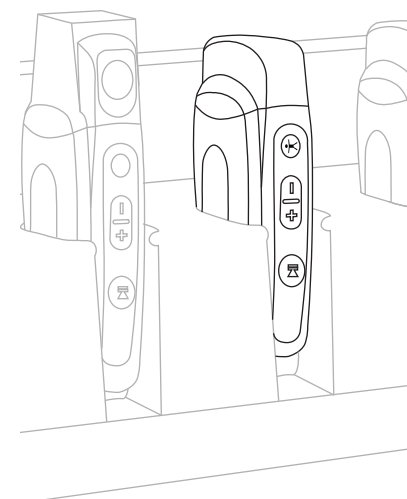

5. Detach cable clips

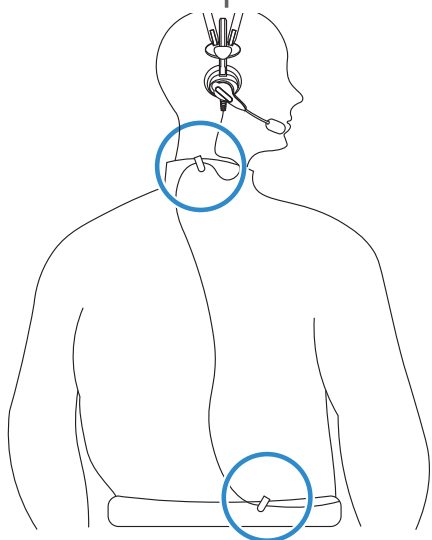

6. Remove headset

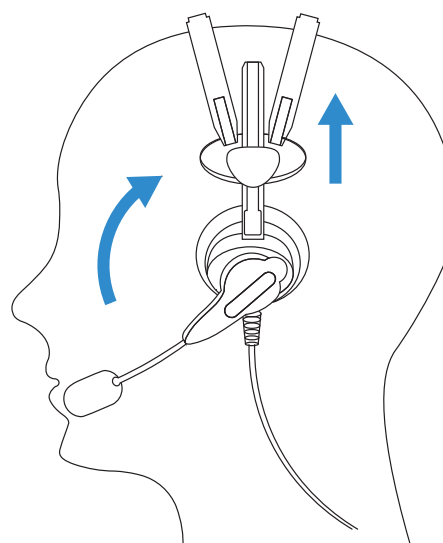

7. Remove belt

Release buckle

